

# MCV 1,5/ 4-GF-3,5 - PCB header



1843240

<https://www.phoenixcontact.com/us/products/1843240>

Please be informed that the data shown in this PDF document is generated from our online catalog. Please find the complete data in the user documentation. Our general terms of use for downloads are valid.

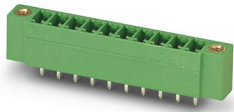

PCB headers, nominal cross section: 1.5 mm<sup>2</sup>, color: green, nominal current: 8 A, rated voltage (III/2): 160 V, contact surface: Tin, contact connection type: Pin, number of potentials: 4, number of rows: 1, number of positions: 4, number of connections: 4, product range: MCV 1,5/..-GF, pitch: 3.5 mm, mounting: Wave soldering, pin layout: Linear pinning, solder pin [P]: 3.4 mm, number of solder pins per potential: 1, plug-in system: COMBICON MC 1,5, Pin connector pattern alignment: Standard, locking: Screw locking mechanism, mounting: Threaded flange, type of packaging: packed in cardboard

## Your advantages

- Well-known mounting principle allows worldwide use
- Screwable flange for superior mechanical stability
- Vertical connection enables multi-row arrangement on the PCB
- Maximum flexibility when it comes to device design – one header for connectors with different connection technologies

## Commercial data

Item number	1843240
Packing unit	1 pc
Minimum order quantity	250 pc
Sales key	AA02
Product key	AABSAF
Catalog page	Page 227 (C-1-2013)
GTIN	4017918112431
Weight per piece (including packing)	2.069 g
Weight per piece (excluding packing)	2.069 g
Customs tariff number	85366930
Country of origin	DE

# MCV 1,5/ 4-GF-3,5 - PCB header



1843240

<https://www.phoenixcontact.com/us/products/1843240>

## Technical data

### Product properties

Type	Standard
Product line	COMBICON Connectors S
Product type	PCB headers
Product family	MCV 1,5/...-GF
Number of positions	4
Pitch	3.5 mm
Number of connections	4
Number of rows	1
Mounting flange	Threaded flange
Number of potentials	4
Pin layout	Linear pinning
Solder pins per potential	1

### Electrical properties

Nominal current $I_N$	8 A
Nominal voltage $U_N$	160 V
Degree of pollution	3
Contact resistance	1.7 m $\Omega$
Rated voltage (III/3)	160 V
Rated surge voltage (III/3)	2.5 kV
Rated voltage (III/2)	160 V
Rated surge voltage (III/2)	2.5 kV
Rated voltage (II/2)	250 V
Rated surge voltage (II/2)	2.5 kV

### Mounting

Mounting type	Wave soldering
Pin layout	Linear pinning

### Flange

Tightening torque	0.3 Nm
-------------------	--------

### Material specifications

#### Material data - contact

Note	WEEE/RoHS-compliant, free of whiskers according to IEC 60068-2-82/JEDEC JESD 201
Contact material	Cu alloy
Surface characteristics	Tin-plated
Metal surface contact area (top layer)	Tin (3 - 5 $\mu\text{m}$ Sn)
Metal surface contact area (middle layer)	Nickel (1 - 3 $\mu\text{m}$ Ni)
Metal surface soldering area (top layer)	Tin (3 - 5 $\mu\text{m}$ Sn)

# MCV 1,5/ 4-GF-3,5 - PCB header

1843240

<https://www.phoenixcontact.com/us/products/1843240>

Metal surface soldering area (middle layer)	Nickel (1 - 3 µm Ni)
---	----------------------

## Material data - housing

Color (Housing)	green (6021)
Insulating material	PBT
Insulating material group	IIIa
CTI according to IEC 60112	225
Flammability rating according to UL 94	V0

## Dimensions

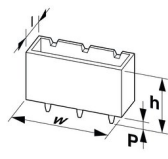
Dimensional drawing	
Pitch	3.5 mm
Width [w]	24.3 mm
Height [h]	12.6 mm
Length [l]	7.25 mm
Installed height	9.2 mm
Solder pin length [P]	3.4 mm
Pin dimensions	0.8 x 0.8 mm

## Mechanical tests

### Visual inspection

Specification	IEC 60512-1-1:2002-02
Result	Test passed

### Dimension check

Specification	IEC 60512-1-2:2002-02
Result	Test passed

### Resistance of inscriptions

Specification	IEC 60068-2-70:1995-12
Result	Test passed

### Polarization and coding

Specification	IEC 60512-13-5:2006-02
Result	Test passed

### Contact holder in insert

Specification	IEC 60512-15-1:2008-05
Contact holder in insert Requirements >20 N	Test passed

### Insertion and withdrawal forces

# MCV 1,5/ 4-GF-3,5 - PCB header



1843240

<https://www.phoenixcontact.com/us/products/1843240>

Result	Test passed
No. of cycles	25
Insertion strength per pos. approx.	8 N
Withdraw strength per pos. approx.	6 N

## Electrical tests

### Thermal test | Test group C

Specification	IEC 60512-5-1:2002-02
Tested number of positions	20

### Insulation resistance

Specification	IEC 60512-3-1:2002-02
Insulation resistance, neighboring positions	> 5 MΩ

### Air clearances and creepage distances |

Specification	IEC 60664-1:2007-04
Insulating material group	IIIa
Comparative tracking index (IEC 60112)	CTI 225
Rated insulation voltage (III/3)	160 V
Rated surge voltage (III/3)	2.5 kV
minimum clearance value - non-homogenous field (III/3)	1.5 mm
minimum creepage distance (III/3)	2.5 mm
Rated insulation voltage (III/2)	160 V
Rated surge voltage (III/2)	2.5 kV
minimum clearance value - non-homogenous field (III/2)	1.5 mm
minimum creepage distance (III/2)	1.6 mm
Rated insulation voltage (II/2)	250 V
Rated surge voltage (II/2)	2.5 kV
minimum clearance value - non-homogenous field (II/2)	1.5 mm
minimum creepage distance (II/2)	2.5 mm

## Environmental and real-life conditions

### Vibration test

Specification	IEC 60068-2-6:2007-12
Frequency	10 - 150 - 10 Hz
Sweep speed	1 octave/min
Amplitude	0.35 mm (10 Hz ... 60.1 Hz)
Sweep speed	5g (60.1 Hz ... 150 Hz)
Test duration per axis	2.5 h

### Durability test

Specification	IEC 60512-9-1:2010-03
Impulse withstand voltage at sea level	2.95 kV
Contact resistance R <sub>1</sub>	1.7 mΩ

# MCV 1,5/ 4-GF-3,5 - PCB header



1843240

<https://www.phoenixcontact.com/us/products/1843240>

Contact resistance $R_2$	1.6 m $\Omega$
Insertion/withdrawal cycles	25
Insulation resistance, neighboring positions	> 5 M $\Omega$

## Climatic test

Specification	ISO 6988:1985-02
Corrosive stress	0.2 dm <sup>3</sup> SO <sub>2</sub> on 300 dm <sup>3</sup> /40 °C/1 cycle
Thermal stress	100 °C/168 h
Power-frequency withstand voltage	1.39 kV

## Ambient conditions

Ambient temperature (operation)	-40 °C ... 100 °C (dependent on the derating curve)
Ambient temperature (storage/transport)	-40 °C ... 70 °C
Relative humidity (storage/transport)	30 % ... 70 %
Ambient temperature (assembly)	-5 °C ... 100 °C

## Packaging specifications

Type of packaging	packed in cardboard
-------------------	---------------------

## Drawings

Diagram

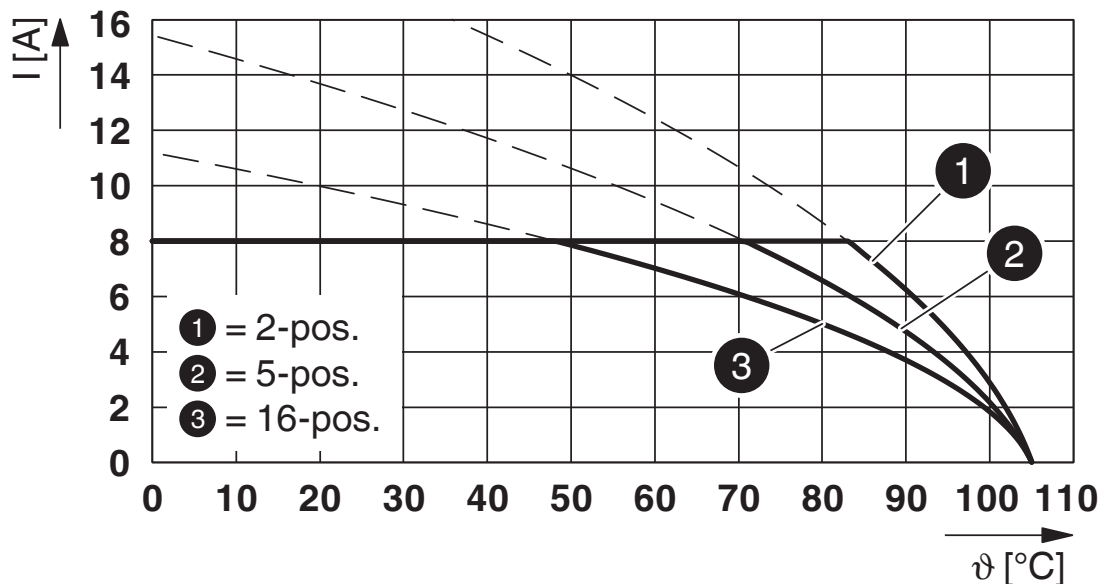

Type: MCVW 1,5/...-STF-3,5 with MCV 1,5/...-GF-3,5

Diagram

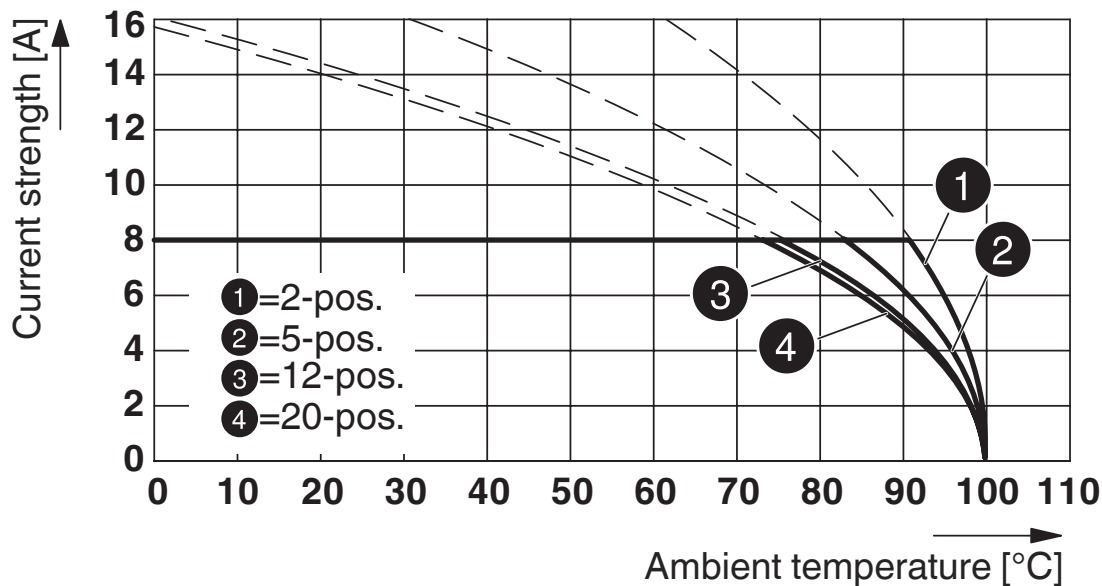

Type: MC 1,5/...-STF-3,5 with MCV 1,5/...-GF-3,5

# MCV 1,5/ 4-GF-3,5 - PCB header

1843240

<https://www.phoenixcontact.com/us/products/1843240>

Drilling plan/solder pad geometry

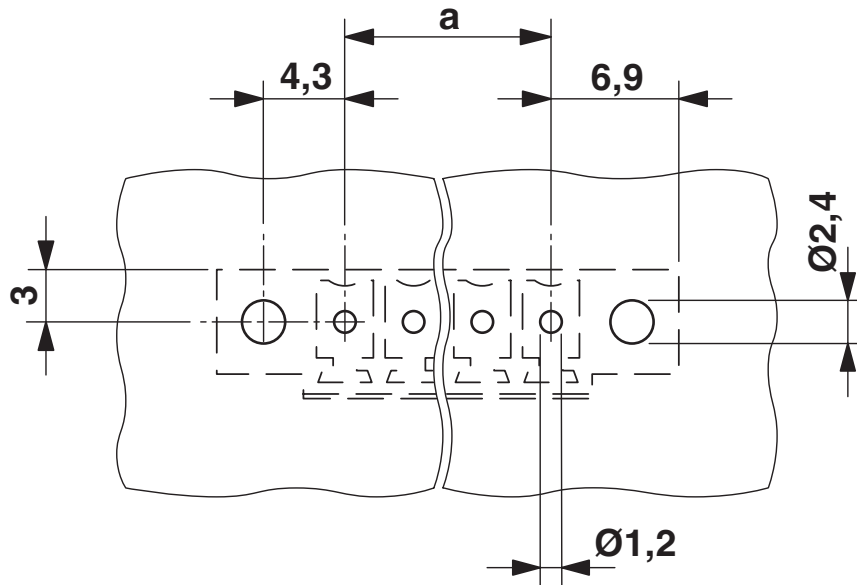

Diagram

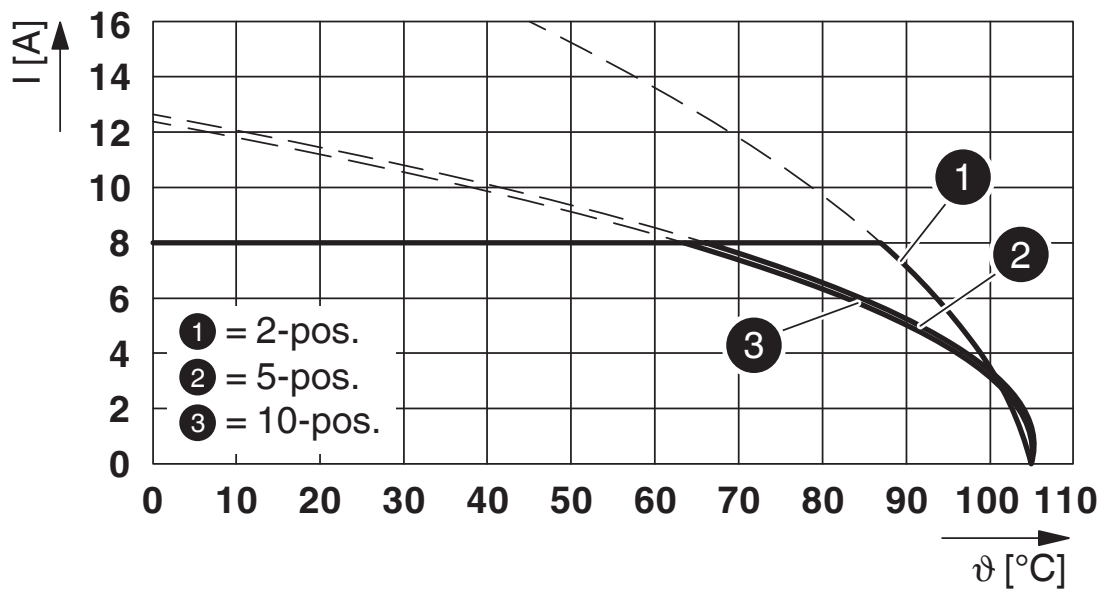

Type: TFMC 1,5/...-STF-3,5 with MCV 1,5/...-GF-3,5

# MCV 1,5/ 4-GF-3,5 - PCB header



1843240

<https://www.phoenixcontact.com/us/products/1843240>

Diagram

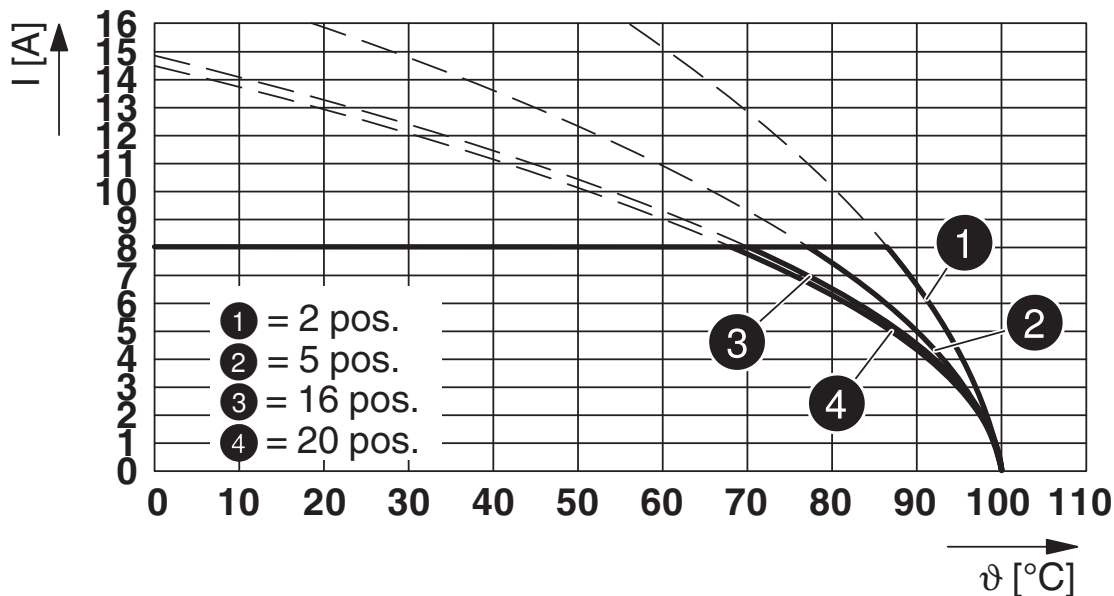

Type: FK-MCP 1,5/...-STF-3,5 with MCV 1,5/...-GF-3,5

Dimensional drawing

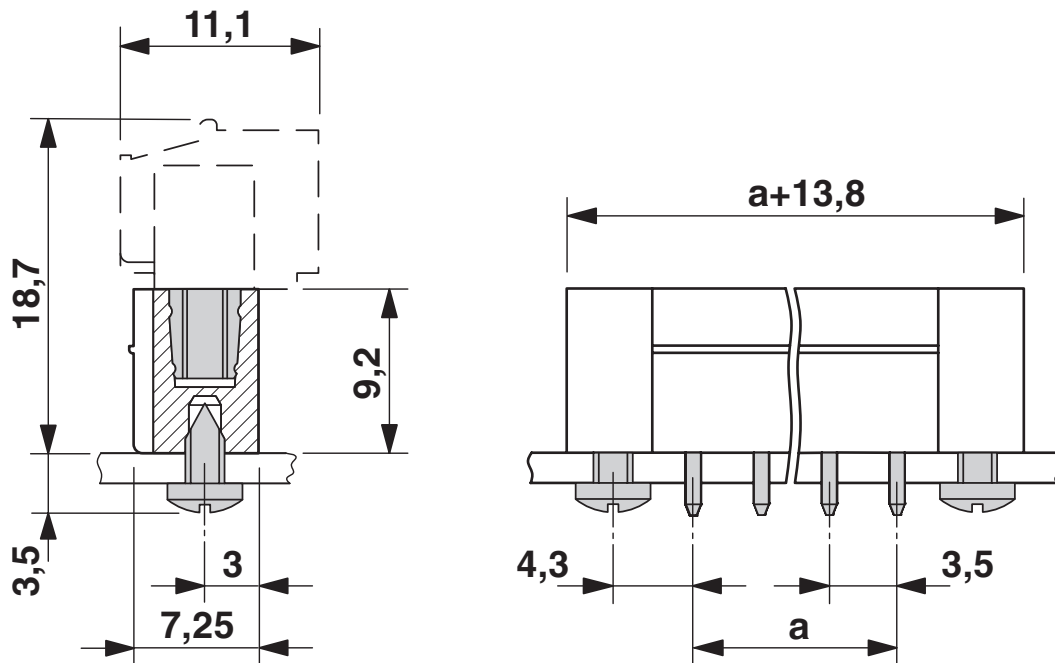

# MCV 1,5/ 4-GF-3,5 - PCB header



1843240

<https://www.phoenixcontact.com/us/products/1843240>



Type: FMC 1,5/...-STF-3,5 with MCV 1,5/...-GF-3,5

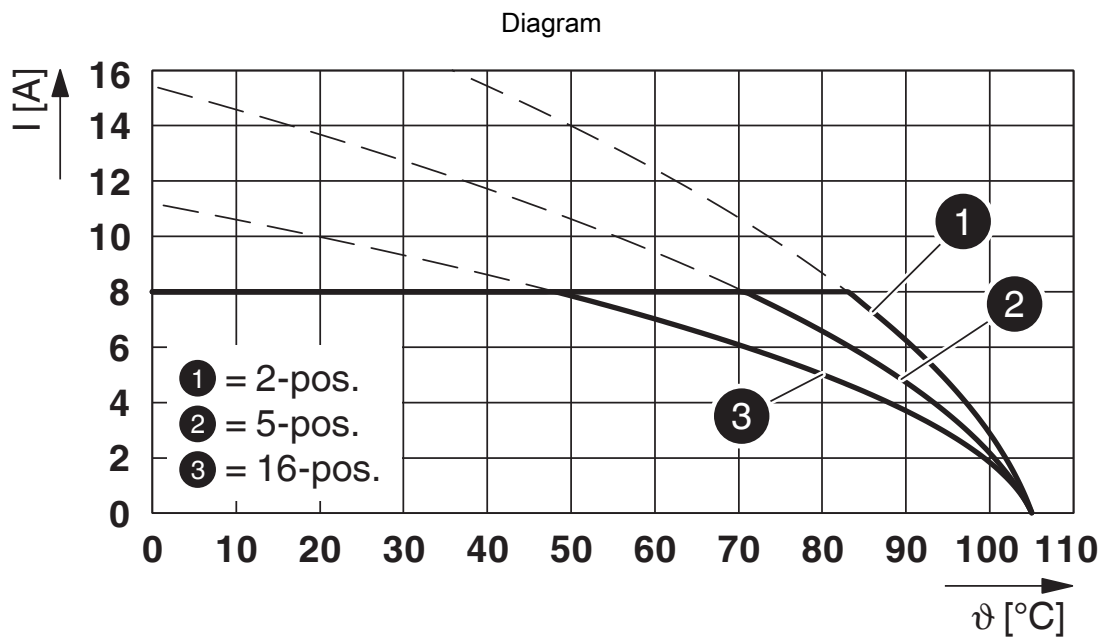

Type: MCVR 1,5/...-STF-3,5 with MCV 1,5/...-GF-3,5

# MCV 1,5/ 4-GF-3,5 - PCB header



1843240

<https://www.phoenixcontact.com/us/products/1843240>

## Approvals

To download certificates, visit the product detail page: <https://www.phoenixcontact.com/us/products/1843240>

 <b>CSA</b> Approval ID: 13631				
	Nominal voltage $U_N$	Nominal current $I_N$	Cross section AWG	Cross section $\text{mm}^2$
Use group B	300 V	8 A	-	-
Use group D	300 V	8 A	-	-

 <b>EAC</b> Approval ID: B.01687				
--	--	--	--	--

 <b>cULus Recognized</b> Approval ID: E60425-20110128				
	Nominal voltage $U_N$	Nominal current $I_N$	Cross section AWG	Cross section $\text{mm}^2$
Use group B	300 V	8 A	-	-
Use group D	300 V	8 A	-	-

 <b>VDE Zeichengenehmigung</b> Approval ID: 40011723				
	Nominal voltage $U_N$	Nominal current $I_N$	Cross section AWG	Cross section $\text{mm}^2$
	160 V	8 A	-	-

# MCV 1,5/ 4-GF-3,5 - PCB header

1843240

<https://www.phoenixcontact.com/us/products/1843240>



## Classifications

### ECLASS

ECLASS-11.0	27460201
ECLASS-12.0	27460201
ECLASS-13.0	27460201

### ETIM

ETIM 8.0	EC002637
----------	----------

### UNSPSC

UNSPSC 21.0	39121400
-------------	----------

# MCV 1,5/ 4-GF-3,5 - PCB header

1843240

<https://www.phoenixcontact.com/us/products/1843240>



## Environmental product compliance

China RoHS	Environmentally friendly use period: unlimited = EFUP-e
	No hazardous substances above threshold values

# MCV 1,5/ 4-GF-3,5 - PCB header

1843240

<https://www.phoenixcontact.com/us/products/1843240>



## Accessories

### SK 3,5/2,8:FORTL.ZAHLEN - Marker card

0804073

<https://www.phoenixcontact.com/us/products/0804073>



Marker card, white, labeled, horizontal: consecutive numbers 1 ... 10, 11 ... 20, etc. up to 91 ... 99, mounting type: adhesive, for terminal block width: 3.5 mm, lettering field size: 3.5 x 2.8 mm

---

### CP-MSTB - Coding profile

1734634

<https://www.phoenixcontact.com/us/products/1734634>



Coding profile, is inserted into the slot on the plug or inverted header, red insulating material

# MCV 1,5/ 4-GF-3,5 - PCB header

1843240

<https://www.phoenixcontact.com/us/products/1843240>



## TFMC 1,5/ 4-STF-3,5 - Printed-circuit board connector

1772728

<https://www.phoenixcontact.com/us/products/1772728>

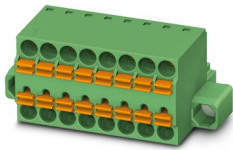

PCB connector, nominal cross section: 1.5 mm<sup>2</sup>, color: green, nominal current: 8 A, rated voltage (III/2): 160 V, contact surface: Tin, contact connection type: Socket, number of potentials: 4, number of rows: 1, number of positions: 4, number of connections: 8, product range: TFMC 1,5/...-STF, pitch: 3.5 mm, connection method: Push-in spring connection, conductor/PCB connection direction: 0 °, plug-in system: COMBICON MC 1,5, locking: Screw locking mechanism, mounting: Screw flange, type of packaging: packed in cardboard

## MC 1,5/ 4-STF-3,5 - PCB connector

1847071

<https://www.phoenixcontact.com/us/products/1847071>

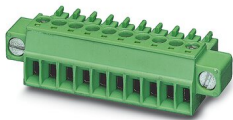

PCB connector, nominal cross section: 1.5 mm<sup>2</sup>, color: green, nominal current: 8 A, rated voltage (III/2): 160 V, contact surface: Tin, contact connection type: Socket, number of potentials: 4, number of rows: 1, number of positions: 4, number of connections: 4, product range: MC 1,5/...-STF, pitch: 3.5 mm, connection method: Screw connection with tension sleeve, screw head form: L Slotted, conductor/PCB connection direction: 0 °, plug-in system: COMBICON MC 1,5, locking: Screw locking mechanism, mounting: Screw flange, type of packaging: packed in cardboard

# MCV 1,5/ 4-GF-3,5 - PCB header

1843240

<https://www.phoenixcontact.com/us/products/1843240>



## MCVW 1,5/ 4-STF-3,5 - PCB connector

1863026

<https://www.phoenixcontact.com/us/products/1863026>



PCB connector, nominal cross section: 1.5 mm<sup>2</sup>, color: green, nominal current: 8 A, rated voltage (III/2): 160 V, contact surface: Tin, contact connection type: Socket, number of potentials: 4, number of rows: 1, number of positions: 4, number of connections: 4, product range: MCVW 1,5/...-STF, pitch: 3.5 mm, connection method: Screw connection with tension sleeve, screw head form: L Slotted, conductor/PCB connection direction: -90 °, plug-in system: COMBICON MC 1,5, locking: Screw locking mechanism, mounting: Screw flange, type of packaging: packed in cardboard

## MCVR 1,5/ 4-STF-3,5 - PCB connector

1863327

<https://www.phoenixcontact.com/us/products/1863327>



PCB connector, nominal cross section: 1.5 mm<sup>2</sup>, color: green, nominal current: 8 A, rated voltage (III/2): 160 V, contact surface: Tin, contact connection type: Socket, number of potentials: 4, number of rows: 1, number of positions: 4, number of connections: 4, product range: MCVR 1,5/...-STF, pitch: 3.5 mm, connection method: Screw connection with tension sleeve, screw head form: L Slotted, conductor/PCB connection direction: 90 °, plug-in system: COMBICON MC 1,5, locking: Screw locking mechanism, mounting: Screw flange, type of packaging: packed in cardboard

# MCV 1,5/ 4-GF-3,5 - PCB header

1843240

<https://www.phoenixcontact.com/us/products/1843240>



## FK-MCP 1,5/ 4-STF-3,5 - PCB connector

1940114

<https://www.phoenixcontact.com/us/products/1940114>

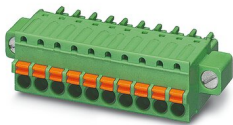

PCB connector, nominal cross section: 1.5 mm<sup>2</sup>, color: green, nominal current: 8 A, rated voltage (III/2): 160 V, contact surface: Tin, contact connection type: Socket, number of potentials: 4, number of rows: 1, number of positions: 4, number of connections: 4, product range: FK-MCP 1,5/..-STF, pitch: 3.5 mm, connection method: Push-in spring connection, conductor/PCB connection direction: 0 °, plug-in system: COMBICON MC 1,5, locking: Screw locking mechanism, mounting: Screw flange, type of packaging: packed in cardboard

## FMC 1,5/ 4-STF-3,5 - Printed-circuit board connector

1966114

<https://www.phoenixcontact.com/us/products/1966114>

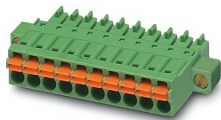

PCB connector, nominal cross section: 1.5 mm<sup>2</sup>, color: green, nominal current: 8 A, rated voltage (III/2): 160 V, contact surface: Tin, contact connection type: Socket, number of potentials: 4, number of rows: 1, number of positions: 4, number of connections: 4, product range: FMC 1,5/..-STF, pitch: 3.5 mm, connection method: Push-in spring connection, conductor/PCB connection direction: 0 °, plug-in system: COMBICON MC 1,5, locking: Screw locking mechanism, mounting: Screw flange, type of packaging: packed in cardboard

Phoenix Contact 2023 © - all rights reserved  
<https://www.phoenixcontact.com>

Phoenix Contact USA  
586 Fulling Mill Road  
Middletown, PA 17057, United States  
(+717) 944-1300  
[info@phoenixcon.com](mailto:info@phoenixcon.com)