



# 3.3V DUAL DIFFERENTIAL LVPECL-TO-LVTTL TRANSLATOR

Precision Edge®  
SY89323L

## FEATURES

- 3.3V power supply
- 1.9ns typical propagation delay
- Maximum frequency > 275MHz
- Differential LVPECL inputs
- 24mA LVTTL outputs
- Flow-through pinouts
- Internal input resistors: pull-down on IN, pull-down and pull-up on /IN
- Q output will default LOW with inputs open
- Available in ultra-small 8-pin MLF® (2mm x 2mm) package



Precision Edge®

## DESCRIPTION

The SY89323L is a dual differential LVPECL-to-LVTTL translator. Because LVPECL (Low Voltage Positive ECL) levels are used, only +3.3V and ground are required. The SY89323L is functionally equivalent to the SY100EPT23L, but in an ultra-small 8-pin MLF® package that features a 70% smaller footprint. The ultra-small package and the dual gate design of the SY89323L make it ideal for applications that require the translation of a clock and data signal in a minimal space. The inputs are compatible with 10k and 100k input levels and any standard differential LVPECL input referenced to a  $V_{CC}$  of 3.3V.

## BLOCK DIAGRAM

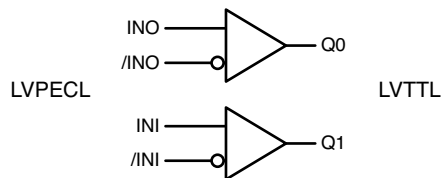

**PACKAGE/ORDERING INFORMATION**

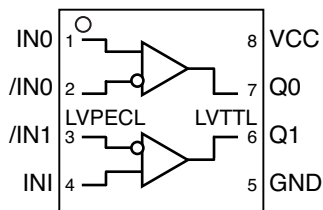

**8-Pin MLF®**  
**Ultra-Small Outline (2mm x 2mm)**

**Ordering Information**

Part Number	Package Type	Operating Range	Package Marking	Lead Finish
SY89323LMITR	MLF-8	Industrial	323	Sn-Pb
SY89323LMGTR <sup>(1)</sup>	MLF-8	Industrial	323 with Pb-Free bar-line indicator	Pb-Free NiPdAu

**Note:**

1. Pb-Free package is recommended for new designs.

**PIN DESCRIPTION**

Pin Number	Pin Name	Type	Pin Function
1, 4	IN0, IN1	ECL Input	Differential PECL/ECL Input: Internal 75kΩ pull-down resistor. If left open, pin defaults LOW. Q output will be LOW. See <i>"Input Interface Applications"</i> section for single-ended inputs.
2, 3	/IN0, /IN1	ECL Input	Differential PECL/ECL Input: Internal 75kΩ pull-up and pull-down resistors. If left floating, pin defaults to V <sub>CC</sub> /2. When not used, this input can be left open. See <i>"Input Interface Applications"</i> section for single-ended inputs.
7, 6	Q0, Q1	LVTTTL Output	Single-ended LVTTTL Outputs: Default to LOW if IN inputs left open.
8	VCC	VCC Power	Positive Power Supply: Bypass with 0.1μF//0.01μF low ESR capacitors.
5	GND, Exposed Pad	Ground	GND and exposed pad must be tied to ground plane.

### Absolute Maximum Ratings<sup>(1)</sup>

Supply Voltage ( $V_{CC}$ )	-0.5V to +3.8V
Input Voltage ( $V_{IN}$ )	-0.5V to $V_{CC}$
LVPECL Output Current ( $I_{OUT}$ )	
Continuous	50mA
Surge	100mA
Input Current	
Source or sink current on IN, /IN	±50mA
Lead Temperature (soldering, 20 sec.)	+260°C
Storage Temperature ( $T_S$ )	-65°C to +150°C

### Operating Ratings<sup>(2)</sup>

Supply Voltage ( $V_{CC}$ )	3.0V to 3.6V
Ambient Temperature ( $T_A$ )	-40°C to +85°C
Package Thermal Resistance, <b>Note 3</b>	
MLF® ( $\theta_{JA}$ )	
Still-Air	93°C/W
500lfpm	87°C/W
MLF® ( $\Psi_{JB}$ )	
Junction-to-Board	60°C/W

## LV TTL DC ELECTRICAL CHARACTERISTICS

$T_A = -40^\circ\text{C}$  to  $+85^\circ\text{C}$ , unless otherwise noted.

Symbol	Parameter	Condition	Min	Typ	Max	Units
$V_{OH}$	Output HIGH Voltage	$I_{OH} = -3.0\text{mA}$	2.0	—	—	V
$V_{OL}$	Output LOW Voltage	$I_{OL} = 24\text{mA}$	—	—	0.5	V
$I_{CC}$	Power Supply Current		—	—	30	mA
$I_{OS}$	Output Short Circuit Current	$V_{OUT} = 0\text{V}$	-80	—	-240	mA

## LVPECL DC ELECTRICAL CHARACTERISTICS

$V_{CC} = +3.3\text{V} \pm 10\%$ ;  $T_A = -40^\circ\text{C}$  to  $+85^\circ\text{C}$ , unless otherwise noted.

Symbol	Parameter	Condition	Min	Typ	Max	Units
$V_{IH}$	Input HIGH Voltage		$V_{CC} - 1.230$	—	$V_{CC} - 0.735$	V
$V_{IL}$	Input LOW Voltage		$V_{CC} - 1.950$	—	$V_{CC} - 1.475$	V
$V_{IHCMR}$	Input HIGH Common Mode Range	<b>Note 4</b>	$V_{EE} + 1.5$	—	$V_{CC}$	V
$V_{PP}$	Minimum Peak-to-Peak Input		200			mV
$I_{IH}$	Input HIGH Current		—	—	150	μA
$I_{IL}$	Input LOW Current	IN	0.5	—	—	μA
		/IN	-300	—	—	μA

**Notes:**

1. Permanent device damage may occur if absolute maximum ratings are exceeded. This is a stress rating only and functional operation is not implied at conditions other than those detailed in the operational sections of this data sheet. Exposure to absolute maximum rating conditions for extended periods may affect device reliability.
2. The data sheet limits are not guaranteed if the device is operated beyond the operating ratings.
3. Package thermal resistance assumes exposed pad is soldered (or equivalent) to the devices most negative potential on the PCB.
4.  $V_{IHCMR}$  (min) varies 1:1 with  $V_{EE}$ , max varies 1:1 with  $V_{CC}$ .

## AC ELECTRICAL CHARACTERISTICS

$V_{CC} = +3.3V \pm 10\%$ ;  $C_L = 20pF$ ,  $T_A = -40^\circ C$  to  $+85^\circ C$ , unless otherwise noted. All parameters guaranteed by design and characterization.

Symbol	Parameter	Condition	Min	Typ	Max	Units
$f_{MAX}$	Maximum Input Frequency	Notes 1, 2	275	—	—	MHz
$t_{pd}$	Propagation Delay		1.5	—	2.5	ns
$t_{skpp}$	Part-to-Part Skew	Notes 3	—	—	0.5	ns
$t_{skew++}$	Within-Device Skew	Notes 4	—	—	0.3	ns
$t_{skew--}$	Within-Device Skew	Notes 5	—	—	0.3	ns
$t_{jitter}$	Cycle-to-Cycle	Note 6			2	$\mu s_{RMS}$
	Total Jitter	Note 7			25	$\mu s_{PP}$
$t_r$ $t_f$	Output Rise/Fall Time 1.0V to 2.0V		0.5	—	1.0	ns

**Notes:**

1. Frequency at which guaranteed for functionality.  $V_{OH}$  and  $V_{OL}$  levels are guaranteed at DC only.
2. The  $f_{MAX}$  value is specified as the minimum guaranteed maximum frequency. Actual operational maximum frequency may be greater.
3. Device-to-Device Skew considering HIGH-to-HIGH transitions at common  $V_{CC}$  level.
4. Within-Device Skew considering HIGH-to-HIGH transitions at common  $V_{CC}$  level.
5. Within-Device Skew considering LOW-to-LOW transitions at common  $V_{CC}$  level.
6. Cycle-to-cycle jitter definition: The variation of periods between adjacent cycles,  $T_n - T_{n-1}$ , where T is the time between rising edges of the output signal.
7. Total jitter definition: with an ideal clock input of frequency  $\leq f_{MAX}$ , no more than one output edge in  $10^{12}$  output edge will deviate by more than the specified peak-to-peak jitter value.

## INPUT INTERFACE APPLICATIONS

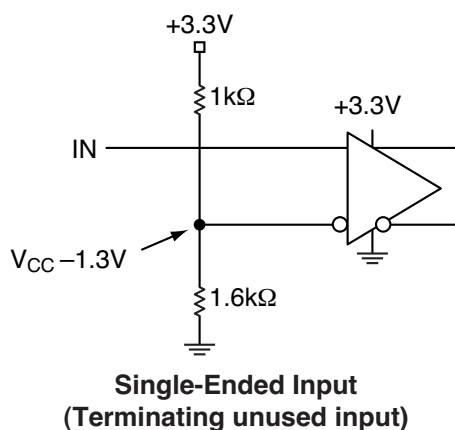

**8-PIN ULTRA-SMALL EPAD-MicroLeadFrame® (MLF-8)**

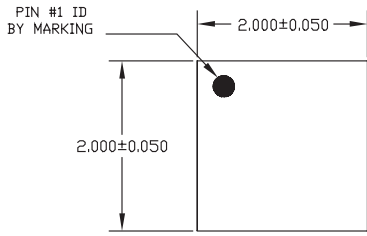

TOP VIEW

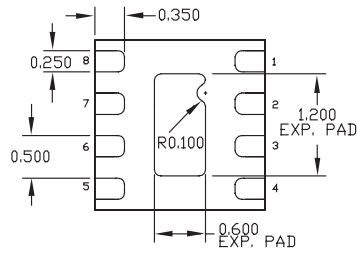

BOTTOM VIEW

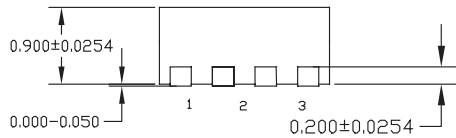

SIDE VIEW

- NOTE:
1. ALL DIMENSIONS ARE IN MILLIMETERS.
  2. MAX. PACKAGE WARPAGE IS 0.05 mm.
  3. MAXIMUM ALLOWABLE BURRS IS 0.076 mm IN ALL DIRECTIONS.
  4. PIN #1 ID ON TOP WILL BE LASER/INK MARKED.

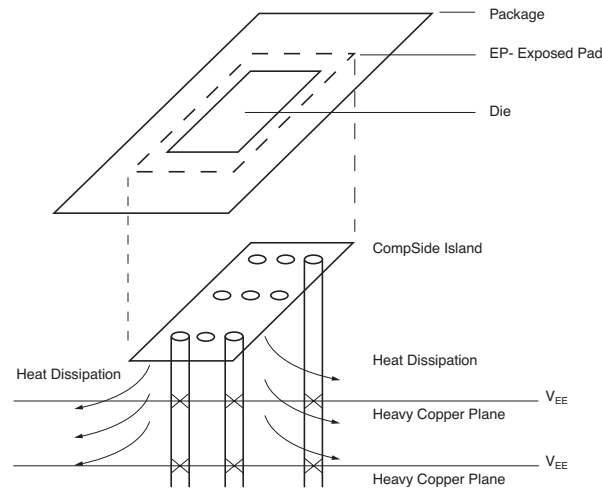

**PCB Thermal Consideration for 8-Pin MLF® Package**

**Package Notes:**

1. Package meets Level 2 qualification.
2. All parts are dry-packaged before shipment.
3. Exposed pads must be soldered to a ground for proper thermal management.

**MICREL, INC. 2180 FORTUNE DRIVE SAN JOSE, CA 95131 USA**

TEL + 1 (408) 944-0800 FAX + 1 (408) 474-1000 WEB <http://www.micrel.com>

The information furnished by Micrel in this datasheet is believed to be accurate and reliable. However, no responsibility is assumed by Micrel for its use. Micrel reserves the right to change circuitry and specifications at any time without notification to the customer.

Micrel Products are not designed or authorized for use as components in life support appliances, devices or systems where malfunction of a product can reasonably be expected to result in personal injury. Life support devices or systems are devices or systems that (a) are intended for surgical implant into the body or (b) support or sustain life, and whose failure to perform can be reasonably expected to result in a significant injury to the user. A Purchaser's use or sale of Micrel Products for use in life support appliances, devices or systems is at Purchaser's own risk and Purchaser agrees to fully indemnify Micrel for any damages resulting from such use or sale.

© 2006 Micrel, Incorporated.

# Mouser Electronics

Authorized Distributor

Click to View Pricing, Inventory, Delivery & Lifecycle Information:

[Microchip:](#)

[SY89323LMG TR](#) [SY89323LMG-TR](#)