

QTLP600C-2 HER

QTLP600C-3 Yellow

QTLP600C-4 Green

QTLP600C-7 AlGaAs Red

QTLP600C-B Blue

PACKAGE DIMENSIONS

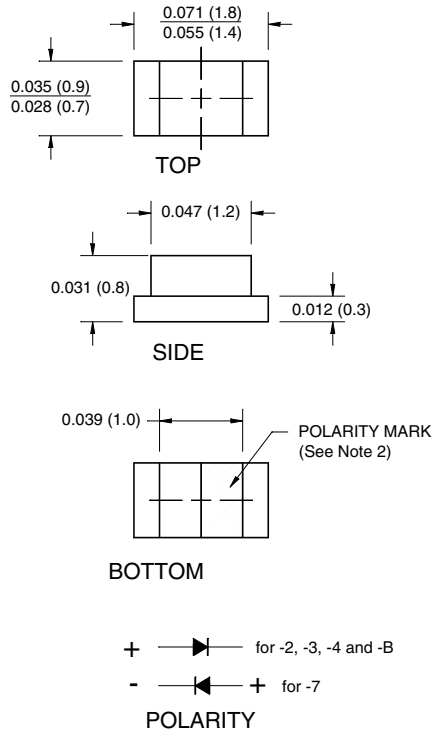

NOTE:

1. Dimensions for all drawings are in inches (mm).
2. Cathode for -2, -3, -4 and B. Anode for -7.

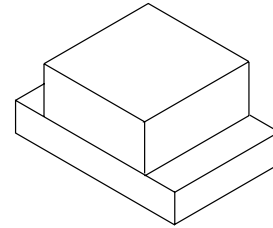

APPLICATIONS

- Keypad backlighting
- Push-button backlighting
- LCD backlighting

DESCRIPTION

These surface mount chip LEDs are designed to fit industry standard footprint. Small size, low profile and wide viewing angle make these LEDs ideal choices for backlighting applications and panel illumination.

FEATURES

- Miniature footprint - 1.6(L) X 0.8(W) X 0.8(H) mm
- Wide viewing angle of 100°
- Water clear optics
- Moisture-proof packaging
- Available in 0.315" (8mm) width tape on 7" (178mm) diameter reel; 2,000 units per reel

SURFACE MOUNT LED LAMP

STANDARD BRIGHT 0603 (0.8 mm Height)

QTLP600C

QTLP600C-2 HER

QTLP600C-3 Yellow

QTLP600C-4 Green

QTLP600C-7 AlGaAs Red

QTLP600C-B Blue

ABSOLUTE MAXIMUM RATINGS ($T_A = 25^\circ\text{C}$ Unless otherwise specified)

Parameter	Symbol	QTLP600C					Units
		-2	-3	-4	-7	-B	
Continuous Forward Current	I_F	30	30	30	30	30	mA
Peak Forward Current ($f = 1.0$ KHz, Duty Factor = 1/10)	I_{FM}	160	160	160	180	100	mA
Reverse Voltage ($I_R = 10 \mu\text{A}$)	V_R	5	5	5	5	5	V
Power Dissipation	P_D	84	84	84	72	135	mW
Operating Temperature	T_{OPR}	-40 to +85					$^\circ\text{C}$
Storage Temperature	T_{STG}	-40 to +90					$^\circ\text{C}$
Lead Soldering Time	T_{SOL}	260 for 5 sec					$^\circ\text{C}$

ELECTRICAL / OPTICAL CHARACTERISTICS ($T_A = 25^\circ\text{C}$)

Part Number	Symbol	QTLP600C					Condition
		-2	-3	-4	-7	-B	
Luminous Intensity (mcd)	I_V	5	5	9	10	15	$I_F = 20\text{mA}$
Minimum		9	9	18	20	20	
Forward Voltage (V)	V_F	2.8	2.8	2.8	2.4	4.5	$I_F = 20\text{mA}$
Maximum		2.0	2.0	2.1	1.9	3.8	
Wavelength (nm)	λ_P	635	585	565	660	430	$I_F = 20\text{mA}$
Peak		630	590	570	645	465	
Dominant	λ_D	45	35	30	20	65	$I_F = 20\text{mA}$
Spectral Line Half Width (nm)	$\Delta\lambda$	100	100	100	100	100	$I_F = 20\text{mA}$
Viewing Angle ($^\circ$)	$2\Theta_{1/2}$						

QTLP600C-2 HER

QTLP600C-3 Yellow

QTLP600C-4 Green

QTLP600C-7 AlGaAs Red

QTLP600C-B Blue

TYPICAL PERFORMANCE CURVES

Fig. 1 Forward Current vs. Forward Voltage

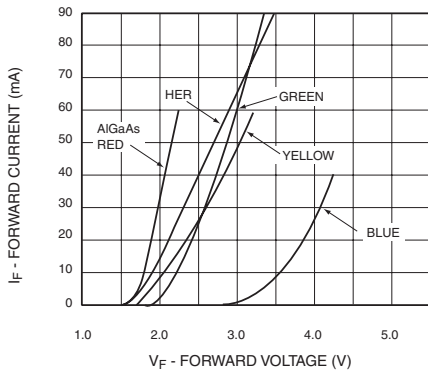

Fig. 2 Relative Luminous Intensity vs. DC Forward Current

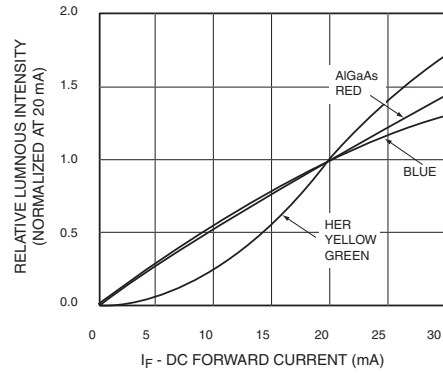

Fig. 3 Relative Intensity vs. Peak Wavelength

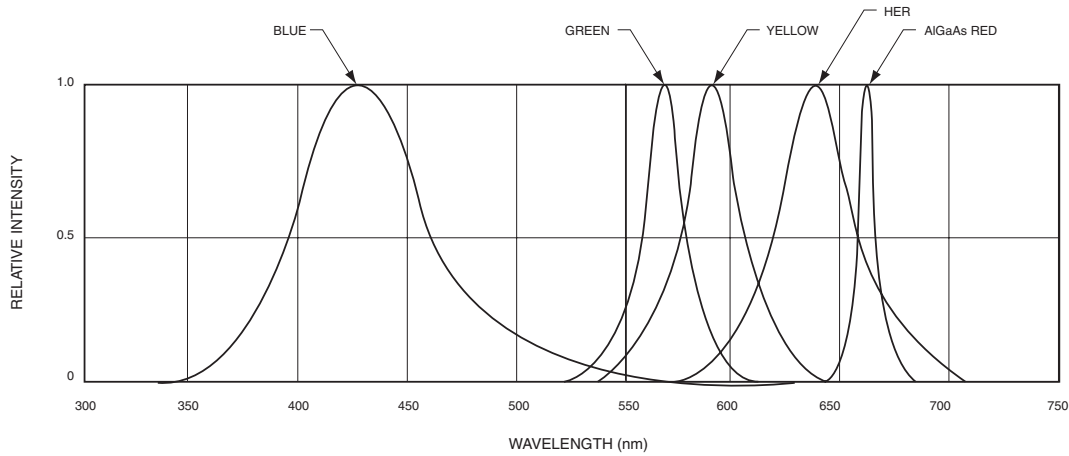

Fig. 4 Radiation Diagram

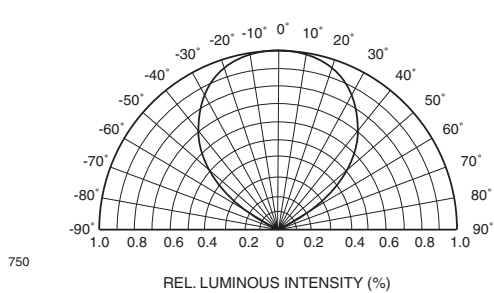
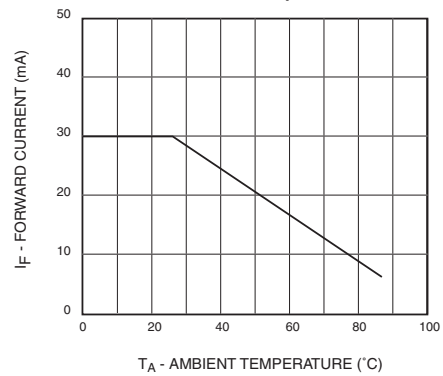

Fig. 5 Maximum Forward Current vs. Ambient Temperature



SURFACE MOUNT LED LAMP

STANDARD BRIGHT 0603 (0.8 mm Height)

QTLP600C

QTLP600C-2 HER

QTLP600C-3 Yellow

QTLP600C-4 Green

QTLP600C-7 AlGaAs Red

QTLP600C-B Blue

RECOMMENDED PRINTED CIRCUIT BOARD PATTERN

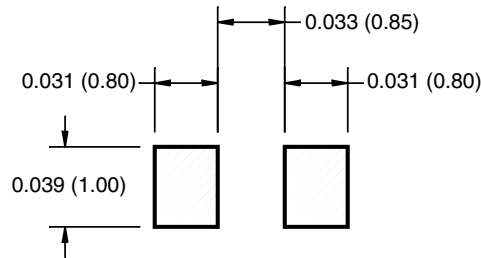

RECOMMENDED IR REFLOW SOLDERING PROFILE

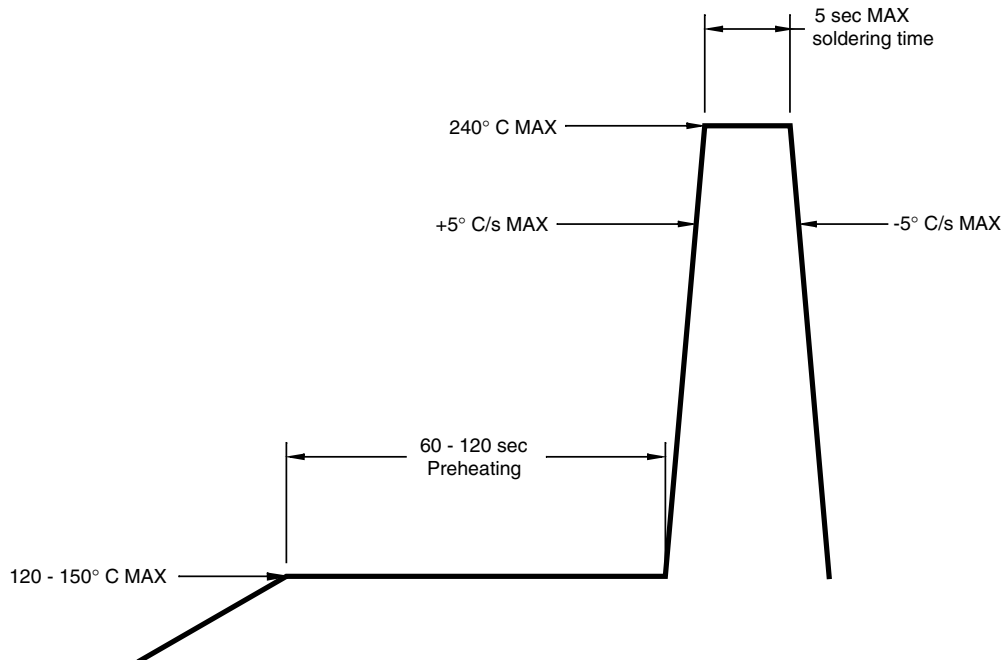

SURFACE MOUNT LED LAMP

STANDARD BRIGHT 0603 (0.8 mm Height)

QTLP600C

QTLP600C-2 HER

QTLP600C-3 Yellow

QTLP600C-4 Green

QTLP600C-7 AlGaAs Red

QTLP600C-B Blue

TAPE AND REEL DIMENSIONS

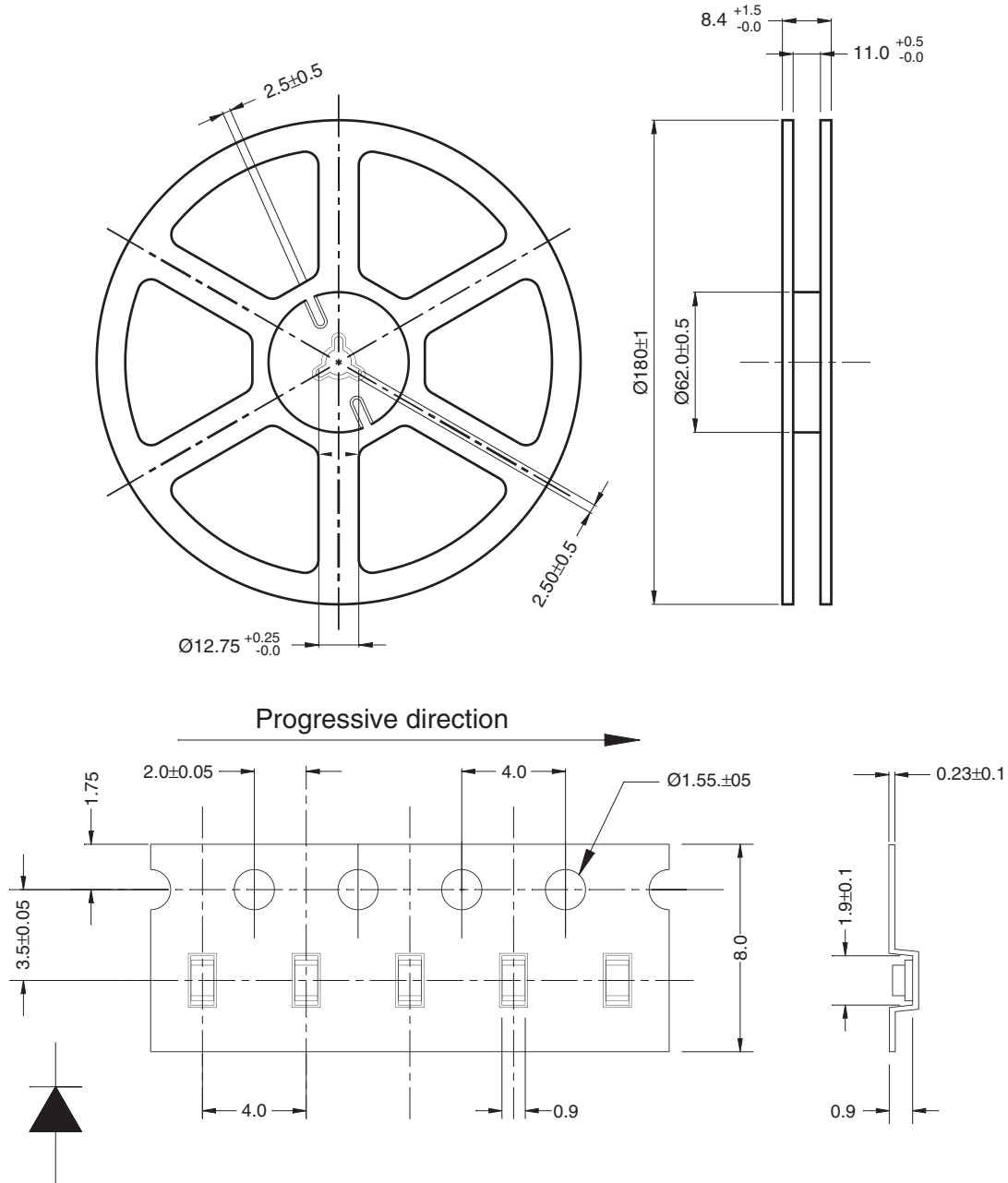

for -2, -3, -4, -B and -7 Dimensional tolerance is ± 0.1 mm unless otherwise specified

Polarity

Angle: ± 0.5

Unit: mm

SURFACE MOUNT LED LAMP STANDARD BRIGHT 0603 (0.8 mm Height) QTLP600C

QTLP600C-2 HER

QTLP600C-3 Yellow

QTLP600C-4 Green

QTLP600C-7 AlGaAs Red

QTLP600C-B Blue

DISCLAIMER

FAIRCHILD SEMICONDUCTOR RESERVES THE RIGHT TO MAKE CHANGES WITHOUT FURTHER NOTICE TO ANY PRODUCTS HEREIN TO IMPROVE RELIABILITY, FUNCTION OR DESIGN. FAIRCHILD DOES NOT ASSUME ANY LIABILITY ARISING OUT OF THE APPLICATION OR USE OF ANY PRODUCT OR CIRCUIT DESCRIBED HEREIN; NEITHER DOES IT CONVEY ANY LICENSE UNDER ITS PATENT RIGHTS, NOR THE RIGHTS OF OTHERS.

LIFE SUPPORT POLICY

FAIRCHILD'S PRODUCTS ARE NOT AUTHORIZED FOR USE AS CRITICAL COMPONENTS IN LIFE SUPPORT DEVICES OR SYSTEMS WITHOUT THE EXPRESS WRITTEN APPROVAL OF THE PRESIDENT OF FAIRCHILD SEMICONDUCTOR CORPORATION. As used herein:

1. Life support devices or systems are devices or systems which, (a) are intended for surgical implant into the body, or (b) support or sustain life, and (c) whose failure to perform when properly used in accordance with instructions for use provided in the labeling, can be reasonably expected to result in a significant injury of the user.
2. A critical component in any component of a life support device or system whose failure to perform can be reasonably expected to cause the failure of the life support device or system, or to affect its safety or effectiveness.