

HF170F

SOLAR RELAY



File No.: E133481



File No.: R 50384178



File No.: CQC17002175164

: CQC18002198581



Features

- 2 Main contact +1 Auxiliary contact
- Detection of main contact welding makes it possible to construct a safety circuit (according to IEC 61810-3)
- Contact gap: 3.6mm(Main contact)
1.0mm(Auxiliary contact)
Auxiliary contact: Min.0.5mm. (When Main contact welded)
- Applicable to solar photovoltaic inverter、AC charging station
- Low coil holding voltage contributes to saving energy of equipment
- 40A switching capability
- Mirror contact mechanisms (Compliant with EN60947-4-1 mirror contact)
- UL insulation system: Class F

RoHS compliant

CONTACT DATA

Contact arrangement		2H	2H1D
Contact resistance (initial)	Main contact	≤10mΩ (6VDC 20A)	
	Auxiliary contact	≤100mΩ(6VDC 1A)	
Contact material	Main contact	AgNi,AgSnO2	
	Auxiliary contact		AgNi
Contact rating (Resistive)	Main contact	40A 277VAC	
	Auxiliary contact		1A 277VAC/30VDC
Max. switching voltage	Main contact	480VAC	
	Auxiliary contact		277VAC,30VDC
Max. switching current	Main contact	40A	
	Auxiliary contact		1A
Max. switching power	Main contact	11080VA	
	Auxiliary contact		277VA/30W
Min. switching load ²⁾ (Auxiliary contact)		NC: 100mA 12VDC NC(Gold plated): 10mA 12VDC	
Mechanical endurance		1 x 10 ⁶ ops	
Electrical endurance	1NO: 35A 277VAC, Resistive load, 85°C, 1s on 9s off, 3 x 10 ⁴ ops		
	1NO: 40A 277VAC, Resistive load, 85°C, 1s on 9s off, 1 x 10 ⁴ ops 2NO: Making 10A Loading 40A Breaking 10A 277VAC, Resistive load, 85°C, 1s on 9s off, 5 x 10 ⁴ ops		
		NC:1A 277VAC/30VDC, Resistive load,85°C, 1s on 9s off, 10 x 10 ⁴ ops	

Notes: 1) The data shown above are initial values.
2) Min. contact load is reference value. Please perform the confirmation test with the actual load before usage since reference value may change according to switching frequencies, environmental conditions and expected life cycles.

COIL DATA

at 23°C

Nominal Voltage VDC	Pick-up Voltage VDC max	Drop-out Voltage VDC min	Max. Voltage VDC *	Coil Resistance Ω
6	4.5	0.3	6.6	19.1 x (1±10%)
9	6.75	0.45	9.9	43.1 x (1±10%)
12	9	0.6	13.2	76.6 x (1±10%)
24	18	1.2	26.4	306.4 x (1±10%)
48	36	2.4	52.8	1225.5 x (1±10%)

Notes: 1) The data shown above are initial values.
2) *Maximum voltage refers to the maximum voltage which relay coil could endure in a short period of time.

CHARACTERISTICS

Contact arrangement		2H	2H1D
Insulation resistance		1000MΩ (500VDC)	
Dielectric strength	Between open main contacts	2000VAC 1min	
	Between main contact and Auxiliary contact		5000VAC 1min
	Between main contacts sets	2000VAC 1min	
	Between coil and Main contacts	5000VAC 1min	
	Between coil and Auxiliary contacts		2000VAC 1min
	Between open Auxiliary contacts		1000VAC 1min
Operate time (at rated. volt.)		≤30ms	
Release time (at rated. volt.)		≤10ms	
Temperature rise		70K max. (Contact load current 40A, Applied voltage of coil 100% rated voltage for 100ms holding voltage of coil 60% rated voltage, at 85°C)	
Shock resistance	Functional	98m/s ²	
	Destructive	980m/s ²	
Vibration resistance		10Hz to 55Hz 1.0mm DA	
Humidity		5% to 85% RH	
Ambient temperature		-40°C to 85°C	
Termination		PCB	
Unit weight		Approx. 66g	
Construction		Flux proofed	

Notes: The data shown above are initial values.

COIL

Coil power	Approx. 1.88W
Holding voltage	30% to 110% U _N (at 25°C) 40% to 60%U _N (at 85°C)

Notes: 1)The coil holding voltage is the voltage applied to coil 100ms after the rated voltage.
2)To avoid overheating and burning, the coil can not be consistently applied to with voltage larger than maximum holding voltage.



HONGFA RELAY

ISO9001, IATF16949, ISO14001, ISO45001, IECQ QC 080000 CERTIFIED

2023 Rev. 1.00

SAFETY APPROVAL RATINGS

UL/CUL	NO	AgSnO ₂	35A 277VAC Resistive 85°C 40A 277VAC Resistive 85°C
		AgNi	Making 10A Loading 40A Breaking 10A, 277VAC Resistive 85°C
	NC	AgNi	1A 277VAC/30VDC Resistive 85°C
TÜV	NO	AgSnO ₂	35A 277VAC Resistive 85°C 40A 277VAC Resistive 85°C
		AgNi	Making 10A Loading 40A Breaking 10A, 277VAC Resistive 85°C
	NC	AgNi	1A 277VAC/30VDC Resistive 85°C
CQC	NO	AgSnO ₂	35A 277VAC Resistive 85°C 40A 277VAC Resistive 85°C
		AgNi	Making 10A Loading 40A Breaking 10A, 277VAC Resistive 85°C
	NC	AgNi	1A 277VAC/30VDC Resistive 85°C

Notes: 1) All values unspecified are at room temperature.

2) Only typical loads are listed above. Other load specifications can be available upon request.

ORDERING INFORMATION

Type	HF170F/	12	-2H	1D	T	F	(XXX)
Coil voltage	6, 9, 12, 24, 48VDC						
Main contact arrangement	2H: 2 Form A						
Auxiliary contact arrangement	Nil: Standard		1D: 1 Form B				
Main contact material	Nil: AgNi		T: AgSnO ₂				
Insulation standard	F: Class F						
Special code ³⁾	XXX: Customer special requirement Nil: Standard 991: Auxiliary contact gold plated						

Notes: 1) Flux-proofed relays should not be used in the polluted environment (containing certain amount of H₂S, SO₂, NO₂, dust and other pollutants)

2) Water cleaning or surface process is not suggested after the flux-proofed relays are assembled on PCB.

3) The customer special requirement express as special code after evaluating by Hongfa.

4) If you need double cutting with zero line firing line, please contact Hongfa.

OUTLINE DIMENSIONS, WIRING DIAGRAM AND PC BOARD LAYOUT

Unit: mm

Outline Dimensions

2H:

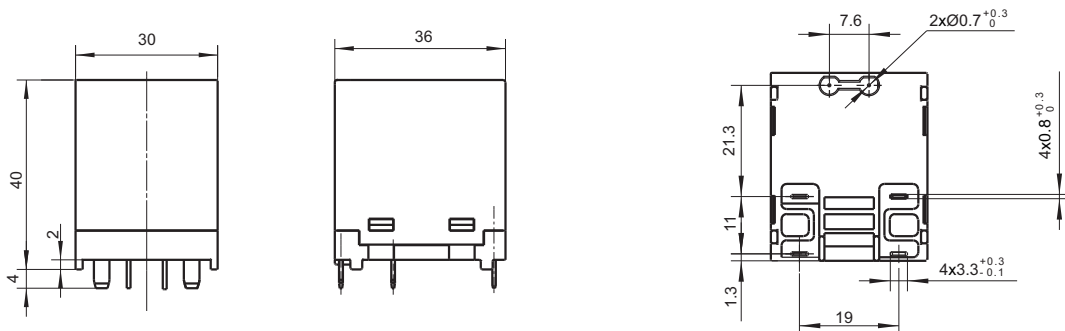

PCB Layout
(Bottom view)

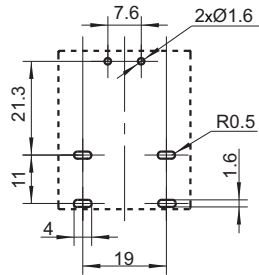

Wiring Diagram
(Bottom view)

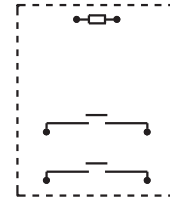

Outline Dimensions

2H1D(with Auxiliary contact) :

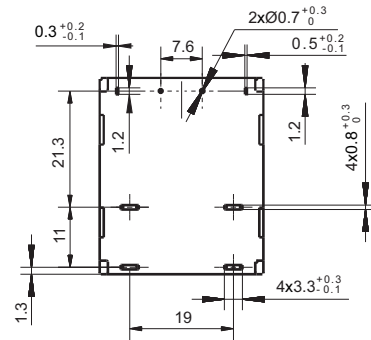
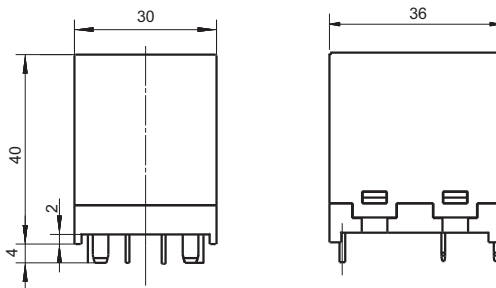

PCB Layout
(Bottom view)

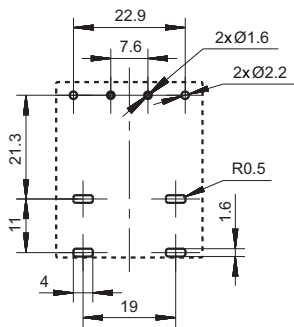

Wiring Diagram
(Bottom view)

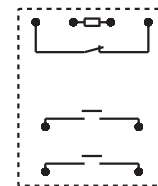

- Remark: 1) In case of no tolerance shown in outline dimension: outline dimension $\leq 1\text{mm}$, tolerance should be $\pm 0.2\text{mm}$; outline dimension $> 1\text{mm}$ and $\leq 5\text{mm}$, tolerance should be $\pm 0.3\text{mm}$; outline dimension $> 5\text{mm}$, tolerance should be $\pm 0.4\text{mm}$.
2) The tolerance without indicating for PCB layout is always $\pm 0.1\text{mm}$.

Disclaimer

The specification is for reference only. See to "Terminology and Guidelines" for more information. Specifications subject to change without notice. We could not evaluate all the performance and all the parameters for every possible application. Thus the user should be in a right position to choose the suitable product for their own application. If there is any query, please contact Hongfa for the technical service. However, it is the user's responsibility to determine which product should be used only.

© Xiamen Hongfa Electroacoustic Co., Ltd. All rights of Hongfa are reserved.