

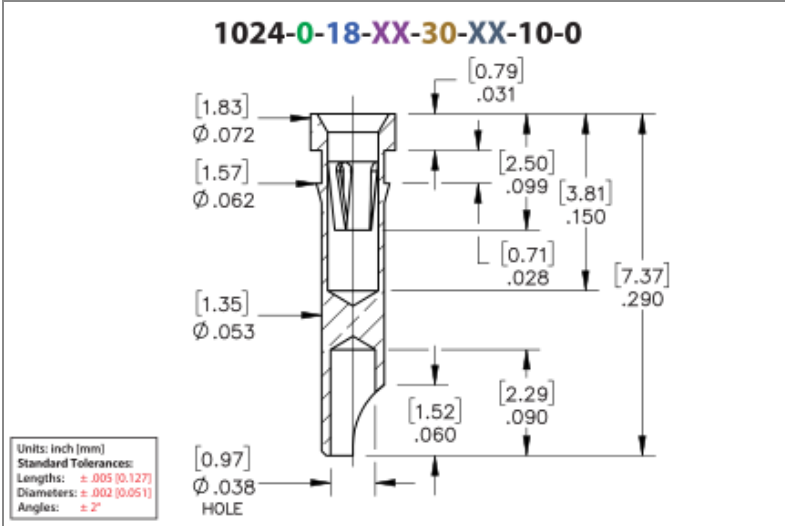

PRODUCT NUMBER: 1024-0-18-15-30-27-10-0

www.mill-max.com
DATA SHEET



1024-0-18-15-30-27-10-0 SPECIFICATIONS

General Info	
Description¹:	Wire Termination Receptacle - Soldercup Type
Mounting Feature:	Press-Fit into a Non-Plated Through Hole (NPTH)
Mounting Hole:	.059" (1,499mm)
Pin Diameter Range:	.015"-.025" (0,381-0,635mm)
Packaging:	Packaged in Bulk
RoHS²:	Yes
Product Lifecycle³:	Active

Materials	
Shell Material⁴:	Brass Alloy
Shell Plating⁵:	10 μ" Gold over Nickel
Contact Plating⁶:	30 μ" Gold over Nickel

Technical Specs	
Durability⁷:	1,000 Cycles Minimum
Operating Temperature Range⁸:	-55/+125° C
Current Rating⁹:	3A @ 10°C Temperature Rise
Contact Resistance¹⁰:	10 mΩ Max
Shock¹¹:	No Elect. Discontinuity > 1μs @ 50g
Vibration¹²:	No Elect. Discontinuity > 1μs @ 10-2000HZ, 20 G

NOTES:

- Standard Tolerances:
Lengths +/- .005" (0,13)
Diameters: +/- .002" (0,051)
Angles: +/- 2°
- Mill-Max products labeled with the RoHS symbol are compliant with all three ROHS Directives. All of our products previously described as RoHS (2002/95/EC) and RoHS-2 (2011/65/EC) are also compliant with RoHS-3 (2015/863/EU).
- Part is Active and in Production, No Scheduled Obsolescence
- Brass Alloy 360 per ASTM B 16, or 385 per ASTM B455
- GOLD per ASTM B 488, Type 1 (99.7% min. gold), Code C (130-200 HK {Knoop hardness}); NICKEL per ASTM B 689, Type 2 (Bright),
- GOLD per ASTM B 488, Type 1 (99.7% min. gold), Code C (130-200 HK {Knoop hardness}), NICKEL per ASTM B 689, Type 2 (Bright)
- Receptacles are capable of 1,000 Minimum insertion/extraction cycles for a broad range of applications. Mating pin size, shape and finish, along with application specific variables, will affect the life of a receptacle contact.
- Per IEC 60512-11-(4,-9,-10,-12)
- Per IEC 60512-5-1, Current Carrying Capacity (evaluated at 10° C Temp. Rise)
- Per EIA-364-23C, Low Level Contact Resistance
- Per IEC 60512-6-3: Test 6c: Shock
- Per IEC 60512-6-4: Test 6d: Vibration (sinusoidal)

CONTACT:

#30 CONTACT FOR .015"-.025" DIAMETER PINS ($\delta = .005$) 4-FINGER (BeCu), GROUP C

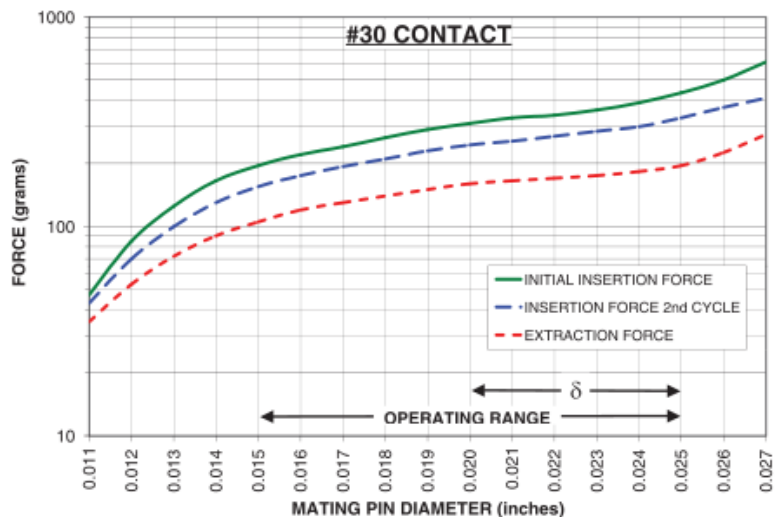
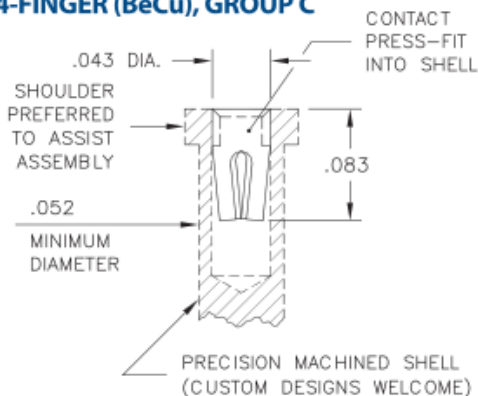

The insertion / extraction force characteristics above were derived using a 30 microinch gold-plated contact and polished steel gauge pins having a bullet-shaped tip. The curves represent typical average values; they are best used to compare the differences between similar size contacts and to guide you in selecting one that is suitable for your application. Your results may vary, so for your specification, we encourage you to obtain complimentary samples for your evaluation.

Material	Beryllium Copper	Current Rating (amps)	3.00
Fingers	4	Compliance (δ)	0.005
Length	.080" (2,032mm)	Contact Group	C

ADDITIONAL NOTES AND SPECIFICATIONS

In the interest of improved design, quality and performance , Mill-Max reserves the right to make changes in its specifications without prior notice. Specifications and tolerances are provided wherever possible. The tolerance on dimensions of critical to function features is typically held tighter than the stated standard tolerances, such as press-fits, holes and lengths affecting the coplanarity of SMT products. Due to the wide variety of interconnects Mill-Max offers, the specific tolerances vary from product to product. If you need information regarding the tolerance of a particular part, please contact Technical Services.

RELATED LINKS AND DOCUMENTS

Application Note: (https://www.mill-max.com/sites/default/files/external/assets/2019-07/pins_receptacles_and_connectors_with_integrated_solder_cups.pdf)

Engineering Notebook: (<https://www.mill-max.com/engineering-notebooks/solder-cup-receptacles>)

Environmental Compliance: (<https://www.mill-max.com/rohs>)