

PCB connector - MC 1,5/ 6-STF-3,81



1827745

<https://www.phoenixcontact.com/us/products/1827745>

Please be informed that the data shown in this PDF document is generated from our Online Catalog. Please find the complete data in the user documentation. Our General Terms of Use for Downloads are valid.

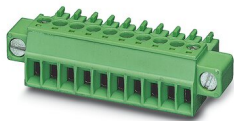

PCB connector, nominal cross section: 1.5 mm², color: green, nominal current: 8 A, rated voltage (III/2): 160 V, contact surface: Tin, type of contact: Female connector, number of potentials: 6, number of rows: 1, number of positions: 6, number of connections: 6, product range: MC 1,5/..-STF, pitch: 3.81 mm, connection method: Screw connection with tension sleeve, screw head form: L Slotted, conductor/PCB connection direction: 0 °, number of solder pins per potential: 1, plug-in system: COMBICON MC 1,5, locking: Screw locking, mounting: Screw flange, type of packaging: packed in cardboard

Your advantages

- Well-known connection principle allows worldwide use
- Low temperature rise, thanks to maximum contact force
- Allows connection of two conductors
- Screwable flange for superior mechanical stability

Commercial Data

Item number	1827745
Packing unit	1 pc
Minimum order quantity	1 pc
Sales Key	A01
Product Key	AABABB
Catalog Page	Page 191 (C-1-2013)
GTIN	4017918050207
Weight per Piece (including packing)	5.475 g
Weight per Piece (excluding packing)	5.046 g
Customs tariff number	85366990
Country of origin	DE

PCB connector - MC 1,5/ 6-STF-3,81



1827745

<https://www.phoenixcontact.com/us/products/1827745>

Technical Data

Product properties

Type	Standard
Product line	COMBICON Connectors S
Product type	PCB plug
Number of positions	6
Pitch	3.81 mm
Number of connections	6
Number of rows	1
Mounting flange	Screw flange
Number of potentials	6
Solder pins per potential	1

Electrical properties

Nominal current I_N	8 A
Nominal voltage U_N	160 V
Degree of pollution	3
Contact resistance	1.3 m Ω
Rated voltage (III/3)	160 V
Rated surge voltage (III/3)	2.5 kV
Rated voltage (III/2)	160 V
Rated surge voltage (III/2)	2.5 kV

Connection data

Connection technology

Type	Standard
Connector system	COMBICON MC 1,5
Nominal cross section	1.5 mm ²
Type of contact	Female connector

Interlock

Locking type	Screw locking
Mounting flange	Screw flange
Tightening torque	0.3 Nm

Conductor connection

Connection method	Screw connection with tension sleeve
Conductor/PCB connection direction	0 °
Conductor cross section solid	0.14 mm ² ... 1.5 mm ²
Conductor cross section flexible	0.14 mm ² ... 1.5 mm ²
Conductor cross section AWG	28 ... 16
Conductor cross section flexible, with ferrule without plastic sleeve	0.25 mm ² ... 1.5 mm ²

PCB connector - MC 1,5/ 6-STF-3,81



1827745

<https://www.phoenixcontact.com/us/products/1827745>

Conductor cross section, flexible, with ferrule, with plastic sleeve	0.25 mm ² ... 0.75 mm ²
2 conductors with same cross section, solid	0.08 mm ² ... 0.5 mm ²
2 conductors with same cross section, flexible	0.08 mm ² ... 0.75 mm ²
2 conductors with same cross section, flexible, with ferrule without plastic sleeve	0.25 mm ² ... 0.34 mm ²
2 conductors with the same cross section, flexible, with TWIN ferrule with plastic sleeve	0.5 mm ² ... 0.5 mm ²
Cylindrical gauge a x b / diameter	2.4 mm x 1.5 mm / 1.6 mm
Stripping length	7 mm
Tightening torque	0.22 Nm ... 0.25 Nm

Material specifications

Material data - contact

Note	WEEE/RoHS-compliant, free of whiskers according to IEC 60068-2-82/JEDEC JESD 201
Contact material	Cu alloy
Surface characteristics	hot-dip tin-plated
Metal surface terminal point (top layer)	Tin (4 - 8 µm Sn)
Metal surface contact area (top layer)	Tin (4 - 8 µm Sn)

Material data - housing

Housing color	green (6021)
Insulating material	PA
Insulating material group	I
CTI according to IEC 60112	600
Flammability rating according to UL 94	V0
Glow wire flammability index GWFI according to EN 60695-2-12	850
Glow wire ignition temperature GWIT according to EN 60695-2-13	775
Temperature for the ball pressure test according to EN 60695-10-2	125 °C

Dimensions

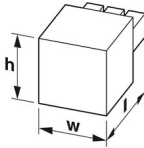
Dimensional drawing	
Pitch	3.81 mm
Width [w]	33.25 mm
Height [h]	11.1 mm
Length [l]	16.1 mm
Installed height	11.1 mm

Mounting

PCB connector - MC 1,5/ 6-STF-3,81



1827745

<https://www.phoenixcontact.com/us/products/1827745>

Drive form screw head	Slotted (L)
Flange	
Tightening torque	0.3 Nm

Mechanical tests

Test for conductor damage and slackening

Specification	IEC 60999-1:1999-11
Result	Test passed

Pull-out test

Specification	IEC 60999-1:1999-11
Conductor cross section/conductor type/tractive force setpoint/actual value	0.14 mm ² / solid / > 7 N
	0.14 mm ² / flexible / > 7 N
	1.5 mm ² / solid / > 40 N
	1.5 mm ² / flexible / > 40 N

Insertion and withdrawal forces

Result	Test passed
No. of cycles	25
Insertion strength per pos. approx.	6 N
Withdraw strength per pos. approx.	4 N

Torque test

Specification	IEC 60999-1:1999-11
---------------	---------------------

Contact holder in insert

Specification	IEC 60512-15-1:2008-05
Contact holder in insert Requirements >20 N	Test passed

Resistance of inscriptions

Specification	IEC 60068-2-70:1995-12
Result	Test passed

Polarization and coding

Specification	IEC 60512-13-5:2006-02
Result	Test passed

Visual inspection

Specification	IEC 60512-1-1:2002-02
Result	Test passed

Dimension check

Specification	IEC 60512-1-2:2002-02
Result	Test passed

Environmental and real-life conditions

PCB connector - MC 1,5/ 6-STF-3,81



1827745

<https://www.phoenixcontact.com/us/products/1827745>

Vibration test

Specification	IEC 60068-2-6:2007-12
Frequency	10 - 150 - 10 Hz
Sweep speed	1 octave/min
Amplitude	0.35 mm (10 - 60.1 Hz)
Sweep speed	5g (60.1 - 150 Hz)
Test duration per axis	2.5 h

Durability test

Specification	IEC 60512-9-1:2010-03
Impulse withstand voltage at sea level	2.95 kV
Contact resistance R ₁	1.3 mΩ
Contact resistance R ₂	1.5 mΩ
Insertion/withdrawal cycles	25
Insulation resistance, neighboring positions	> 5 MΩ

Climatic test

Specification	ISO 6988:1985-02
Corrosive stress	0.2 dm ³ SO ₂ on 300 dm ³ /40 °C/1 cycle
Thermal stress	100 °C/168 h
Power-frequency withstand voltage	1.39 kV

Shocks

Specification	IEC 60068-2-27:2008-02
Pulse shape	Semi-sinusoidal
Acceleration	30g
Shock duration	18 ms
Test directions	X-, Y- and Z-axis (pos. and neg.)

Ambient conditions

Ambient temperature (operation)	-40 °C ... 100 °C (dependent on the derating curve)
Ambient temperature (storage/transport)	-40 °C ... 70 °C
Relative humidity (storage/transport)	30 % ... 70 %
Ambient temperature (assembly)	-5 °C ... 100 °C

Electrical tests

Thermal test | Test group C

Specification	IEC 60512-5-1:2002-02
Tested number of positions	20

Insulation resistance

Specification	IEC 60512-3-1:2002-02
Insulation resistance, neighboring positions	> 5 MΩ

Air clearances and creepage distances |

Specification	IEC 60664-1:2007-04
---------------	---------------------

PCB connector - MC 1,5/ 6-STF-3,81



1827745

<https://www.phoenixcontact.com/us/products/1827745>

Insulating material group	I
Comparative tracking index (IEC 60112)	CTI 600
Rated insulation voltage (III/3)	160 V
Rated surge voltage (III/3)	2.5 kV
minimum clearance value - non-homogenous field (III/3)	1.5 mm
minimum creepage distance (III/3)	2 mm
Note on connection cross section	With connected conductor 1.5 mm ² (solid).
Rated insulation voltage (III/2)	160 V
Rated surge voltage (III/2)	2.5 kV
minimum clearance value - non-homogenous field (III/2)	1.5 mm
minimum creepage distance (III/2)	1.5 mm
Rated insulation voltage (II/2)	320 V
Rated surge voltage (II/2)	2.5 kV
minimum clearance value - non-homogenous field (II/2)	1.5 mm
minimum creepage distance (II/2)	1.6 mm

Packaging specifications

Type of packaging	packed in cardboard
-------------------	---------------------

PCB connector - MC 1,5/ 6-STF-3,81



1827745

<https://www.phoenixcontact.com/us/products/1827745>

Drawings

Diagram

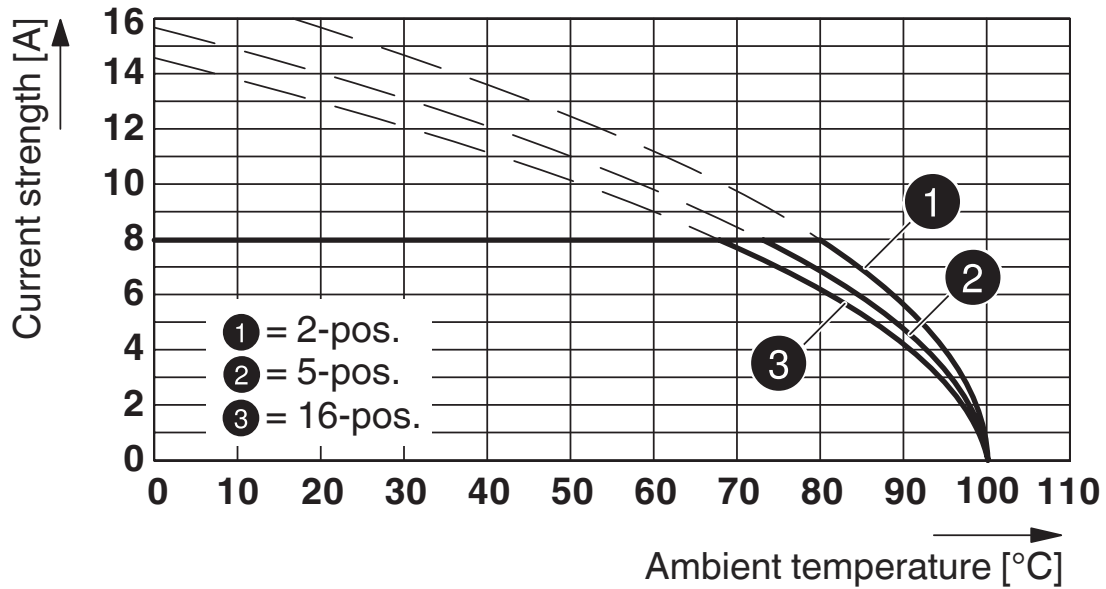

Type: MC 1,5/...-STF-3,81 with DFK-MC 1,5/...-GF-3,81 (with flat plug)

Diagram

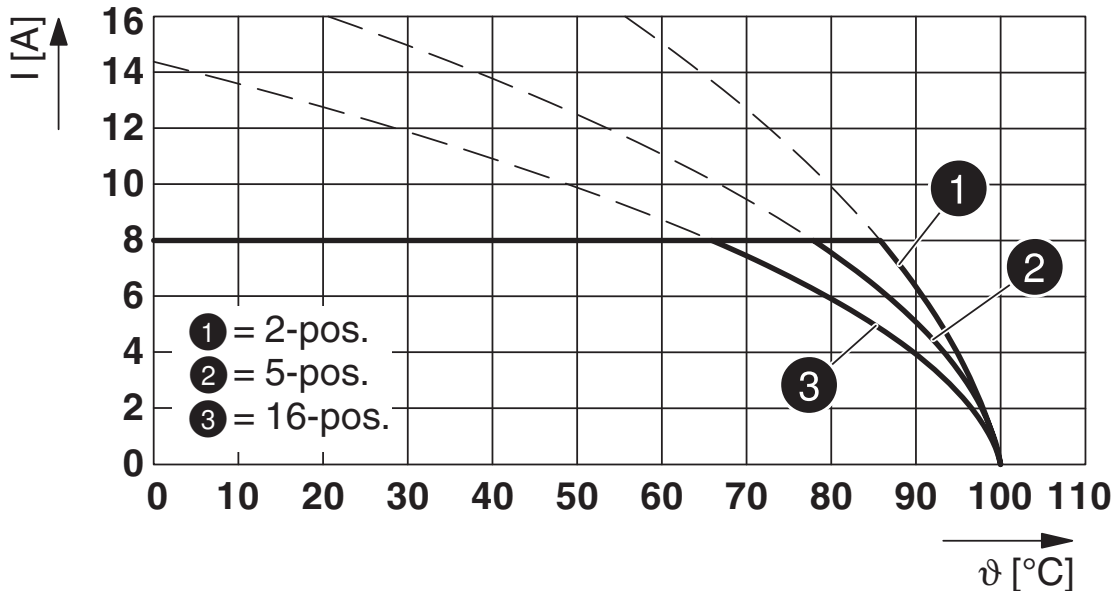

Type: MC 1,5/...-STF-3,81 with MCDV 1,5/...-G1F-3,81

PCB connector - MC 1,5/ 6-STF-3,81



1827745

<https://www.phoenixcontact.com/us/products/1827745>



Type: MC 1,5/...-STF-3,81 with MCD 1,5/...-GF-3,81

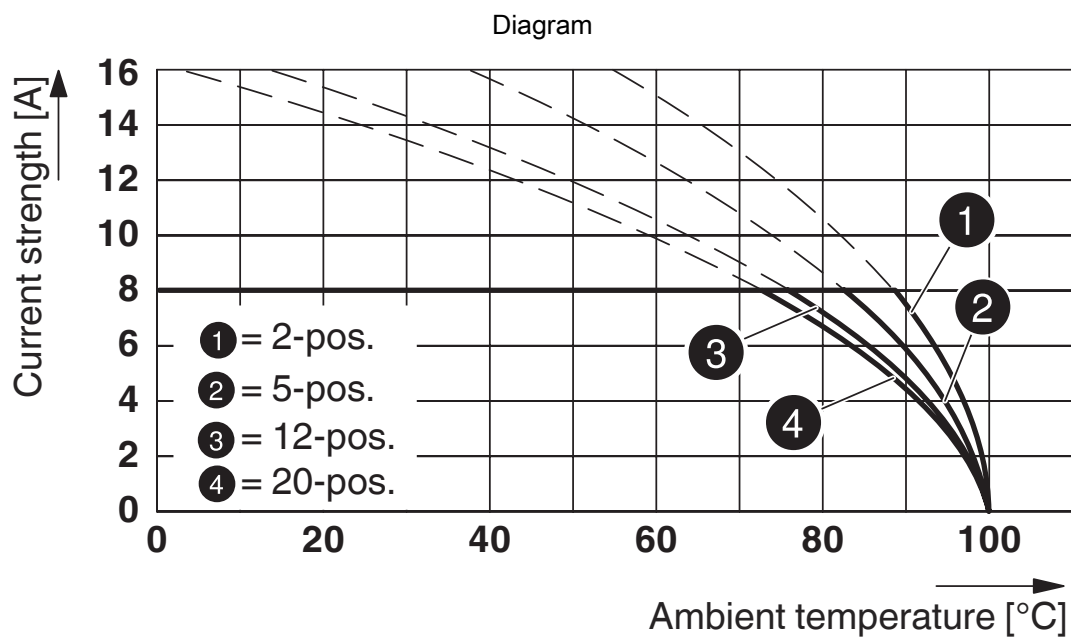

Type: MC 1,5/...-STF-3,81 with MCV 1,5/...-GF-3,81

PCB connector - MC 1,5/ 6-STF-3,81



1827745

<https://www.phoenixcontact.com/us/products/1827745>



Type: MC 1,5/...-STF-3,81 with MCD 1,5/...-G1F-3,81

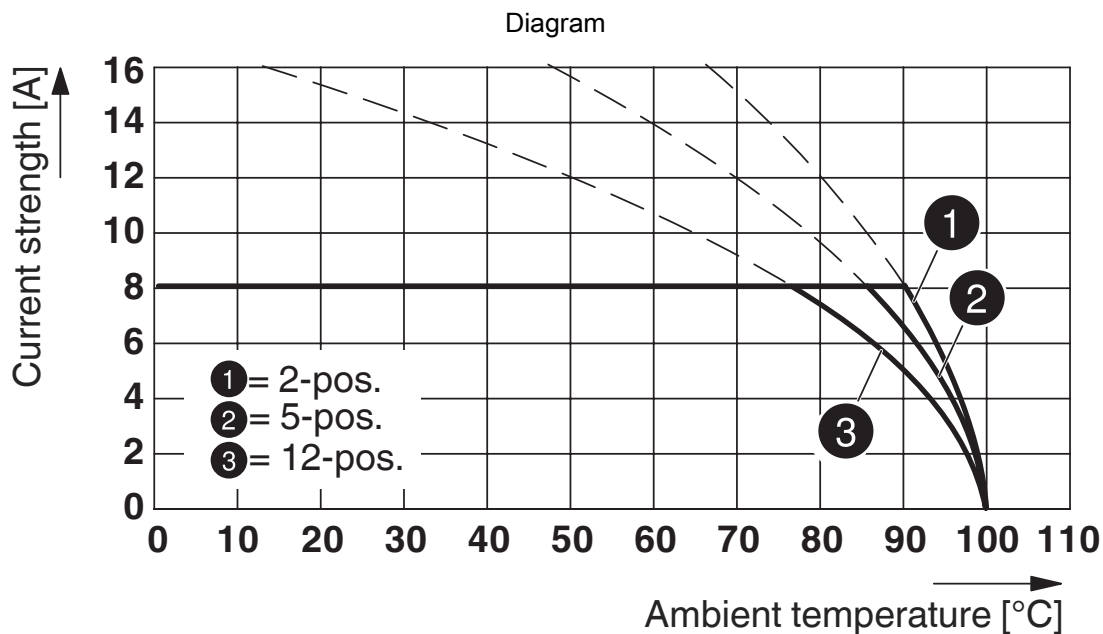

Type: MC 1,5/...-STF-3,81 with MCV 1,5/...-GF-3,81 P26 THR

PCB connector - MC 1,5/ 6-STF-3,81



1827745

<https://www.phoenixcontact.com/us/products/1827745>

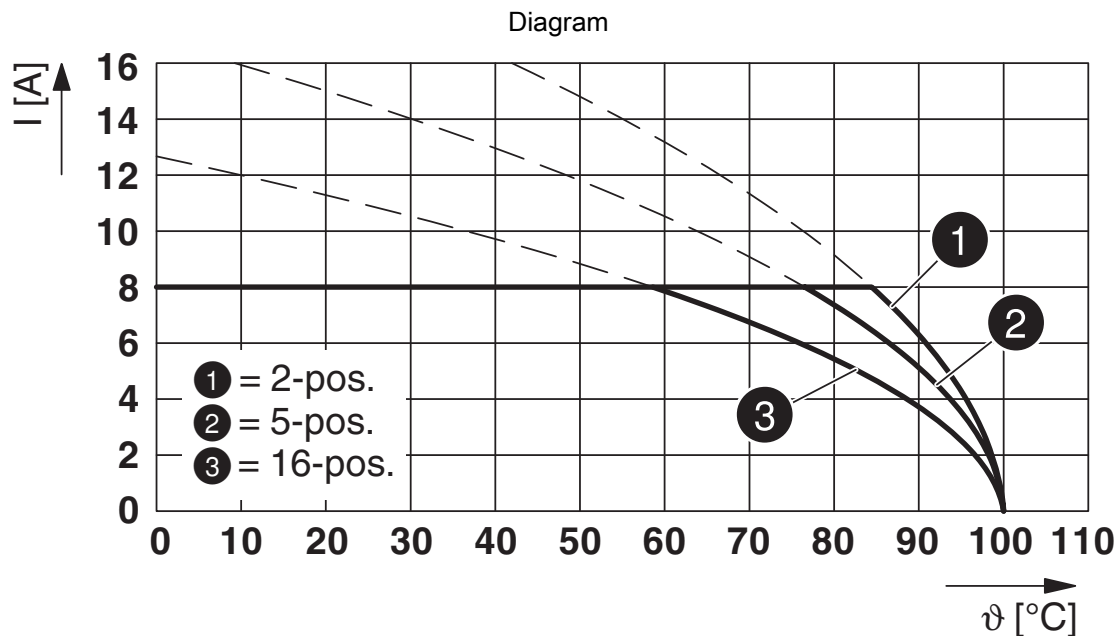

Type: MC 1,5/...-STF-3,81 with MCDV 1,5/...-GF-3,81

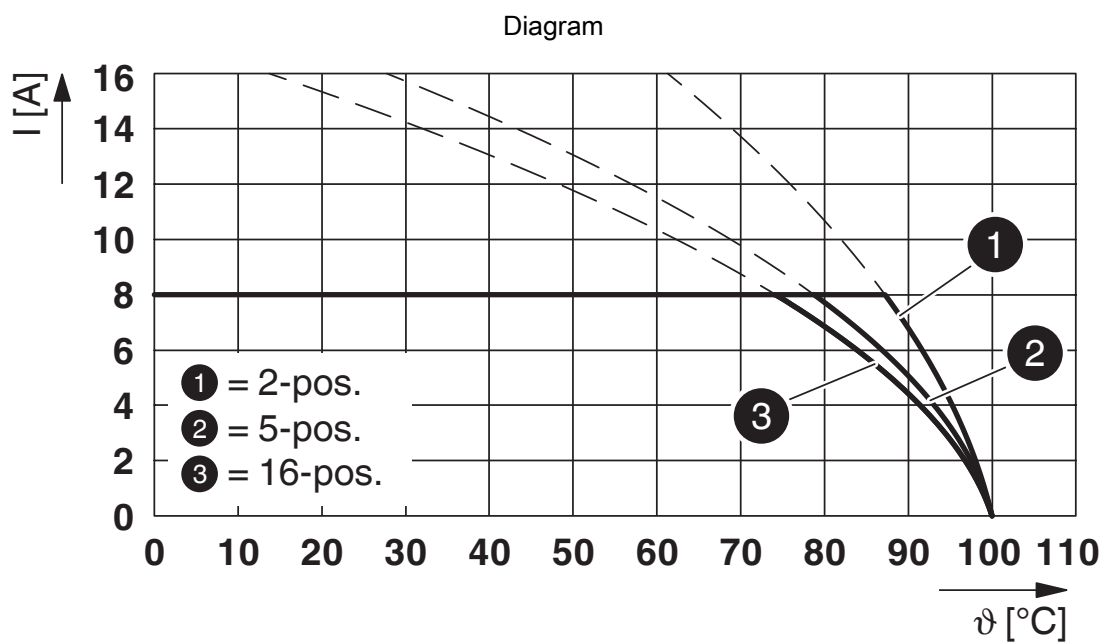

Type: MC 1,5/...-STF-3,81 with SMC 1,5/...-GF-3,81

PCB connector - MC 1,5/ 6-STF-3,81



1827745

<https://www.phoenixcontact.com/us/products/1827745>

Dimensional drawing

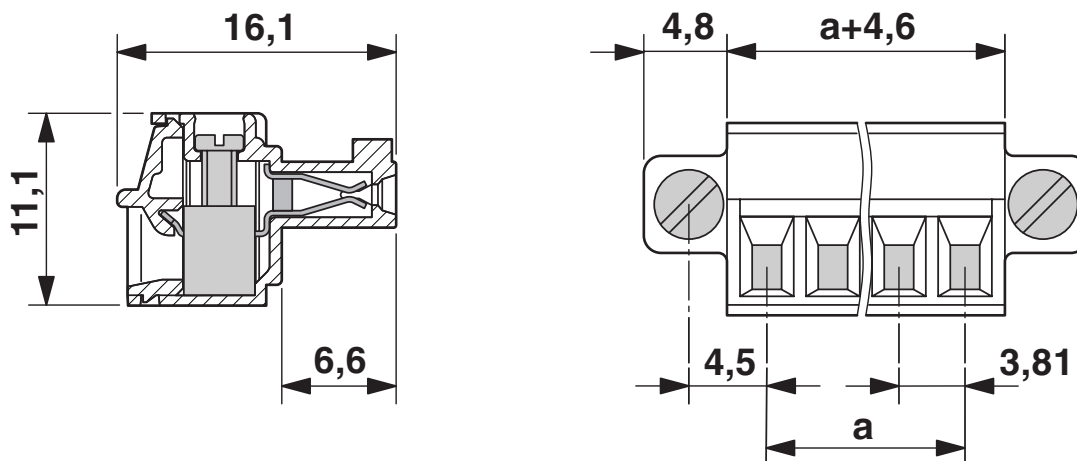

Diagram

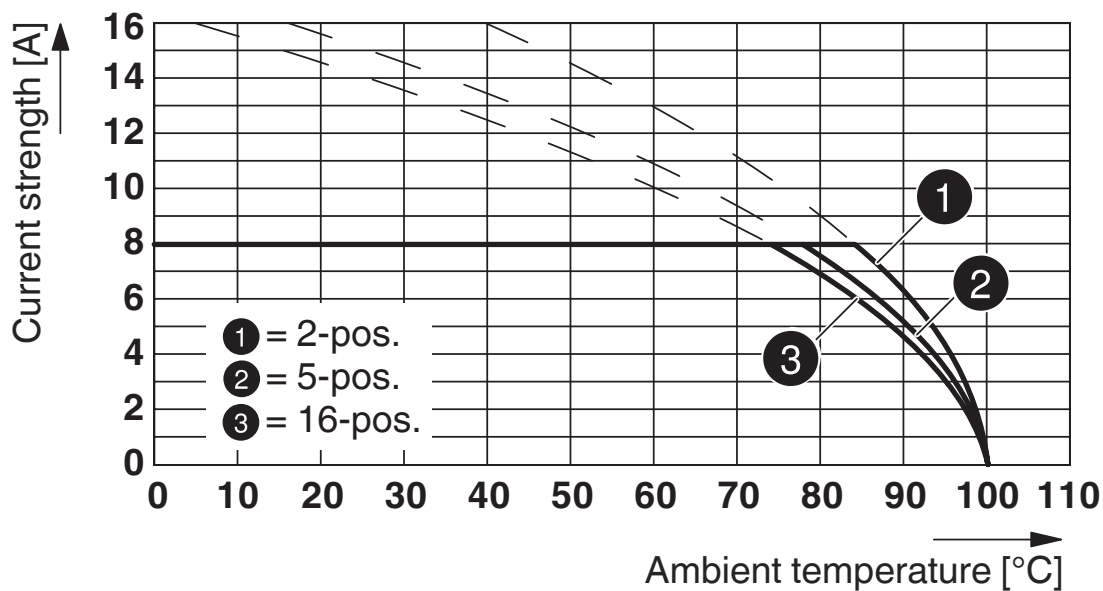

Type: MC 1,5/...-STF-3,81 with DFK-MC 1,5/...-GF-3,81 (with solder connection)

PCB connector - MC 1,5/ 6-STF-3,81



1827745

<https://www.phoenixcontact.com/us/products/1827745>



Type: MC 1,5/...-STF-3,81 with IMC 1,5/...-STGF-3,81

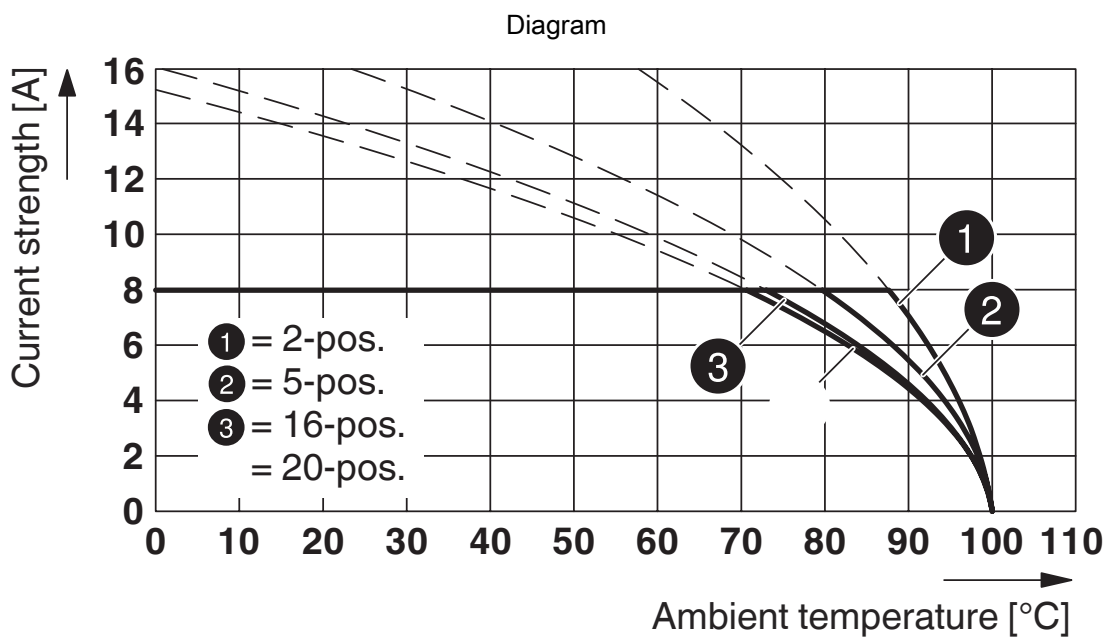

Type: MC 1,5/...-STF-3,81 with MC 1,5/...-GF-3,81 P26THR

PCB connector - MC 1,5/ 6-STF-3,81



1827745

<https://www.phoenixcontact.com/us/products/1827745>

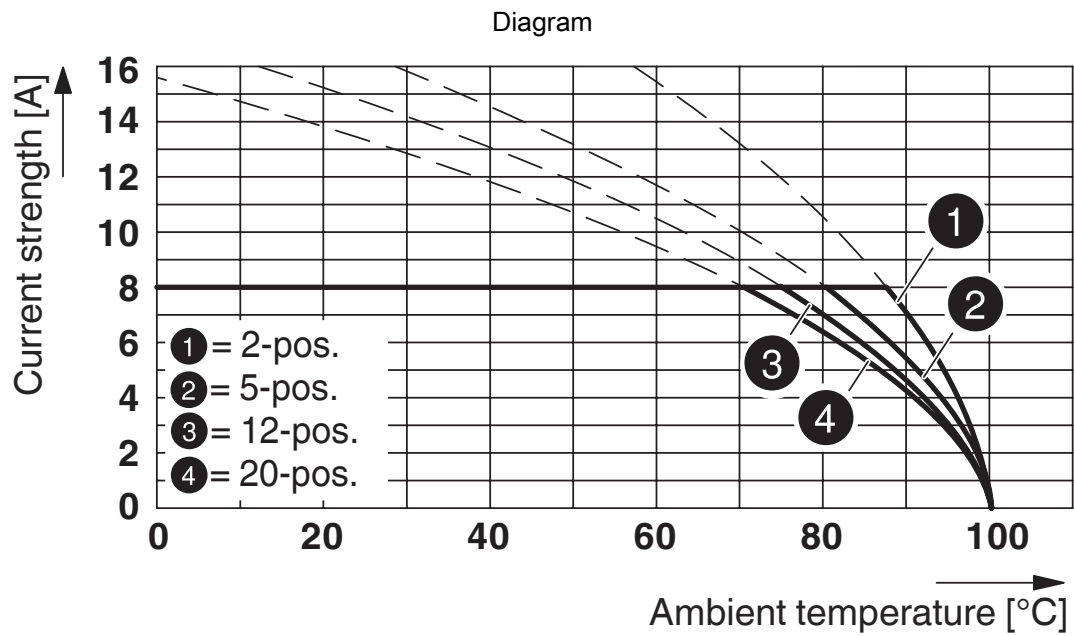

Type: MC 1,5/...-STF-3,81 with MC 1,5/...-GF-3,81

PCB connector - MC 1,5/ 6-STF-3,81



1827745

<https://www.phoenixcontact.com/us/products/1827745>

Approvals

 CSA Approval ID: 13631				
	Nominal Voltage U_N	Nominal Current I_N	Cross Section AWG	Cross Section mm^2
Use group B	300 V	8 A	28 - 16	-
Use group D	300 V	8 A	28 - 16	-

 IECEE CB Scheme Approval ID: DE1-60987-B1B2				
	Nominal Voltage U_N	Nominal Current I_N	Cross Section AWG	Cross Section mm^2
	160 V	8 A	-	0.2 - 1.5

 EAC Approval ID: B.01687				
--	--	--	--	--

 cULus Recognized Approval ID: E60425-20110128				
	Nominal Voltage U_N	Nominal Current I_N	Cross Section AWG	Cross Section mm^2
Use group B	300 V	8 A	30 - 14	-
Use group D	300 V	8 A	30 - 14	-

 VDE Zeichengenehmigung Approval ID: 40011723				
	Nominal Voltage U_N	Nominal Current I_N	Cross Section AWG	Cross Section mm^2
	160 V	8 A	-	-

PCB connector - MC 1,5/ 6-STF-3,81



1827745

<https://www.phoenixcontact.com/us/products/1827745>

Classifications

ECLASS

ECLASS-9.0	27440309
ECLASS-10.0.1	27440309
ECLASS-11.0	27460202

ETIM

ETIM 8.0	EC002638
----------	----------

UNSPSC

UNSPSC 21.0	39121400
-------------	----------

PCB connector - MC 1,5/ 6-STF-3,81



1827745

<https://www.phoenixcontact.com/us/products/1827745>

Environmental Product Compliance

China RoHS	Environmentally friendly use period: unlimited = EFUP-e
	No hazardous substances above threshold values

PCB connector - MC 1,5/ 6-STF-3,81



1827745

<https://www.phoenixcontact.com/us/products/1827745>

Accessories

Marker card

Marker card - SK 3,81/2,8:FORTL.ZAHLEN - 0804109

<https://www.phoenixcontact.com/us/products/0804109>

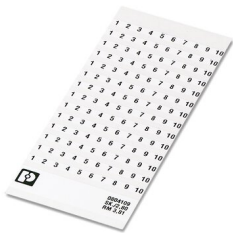

Marker card, white, labeled, horizontal: consecutive numbers 1 ... 10, 11 ... 20, etc. up to 91 ... (99)100, mounting type: adhesive, for terminal block width: 3.81 mm, lettering field size: 3.81 x 2.8 mm

Screwdriver

Screwdriver - SZS 0,4X2,5 VDE - 1205037

<https://www.phoenixcontact.com/us/products/1205037>



Screwdriver, slot-headed, VDE insulated, size: 0.4 x 2.5 x 80 mm, 2-component grip, with non-slip grip

PCB connector - MC 1,5/ 6-STF-3,81



1827745

<https://www.phoenixcontact.com/us/products/1827745>

Cable housing

Cable housing - KGG-MC 1,5/ 6 - 1834385

<https://www.phoenixcontact.com/us/products/1834385>



Cable housing, pitch: 3.81 mm, number of positions: 6, dimension a: 25.25 mm, color: green

Marker card

Marker card - SK U/2,8 WH:UNBEDRUCKT - 0803883

<https://www.phoenixcontact.com/us/products/0803883>



Marker card, Sheet, white, unlabeled, can be labeled with: PLOTMARK, CMS-P1-PLOTTER, Office printing systems, mounting type: adhesive, for terminal block width: 210 mm, lettering field size: 186 x 2.8 mm, Number of individual labels: 3600

PCB connector - MC 1,5/ 6-STF-3,81

1827745

<https://www.phoenixcontact.com/us/products/1827745>



Marker pen

Marker pen - B-STIFT - 1051993

<https://www.phoenixcontact.com/us/products/1051993>



Marker pen, for manual labeling of unprinted Zack strips, smear-proof and waterproof, line thickness 0.5 mm

Insertion bridge

Insertion bridge - EBPL 2-3,81 - 1733495

<https://www.phoenixcontact.com/us/products/1733495>



Insertion bridge for plugs featuring a screw connection with a 3.81 mm pitch

PCB connector - MC 1,5/ 6-STF-3,81

1827745

<https://www.phoenixcontact.com/us/products/1827745>

Insertion bridge

Insertion bridge - EBPL 3-3,81 - 1733505

<https://www.phoenixcontact.com/us/products/1733505>

Insertion bridge for plugs featuring a screw connection with a 3.81 mm pitch



Insertion bridge

Insertion bridge - EBPL 4-3,81 - 1733518

<https://www.phoenixcontact.com/us/products/1733518>

Insertion bridge for plugs featuring a screw connection with a 3.81 mm pitch



PCB connector - MC 1,5/ 6-STF-3,81



1827745

<https://www.phoenixcontact.com/us/products/1827745>

PCB header

PCB header - MCV 1,5/ 6-GF-3,81 P14 THR - 1707256

<https://www.phoenixcontact.com/us/products/1707256>

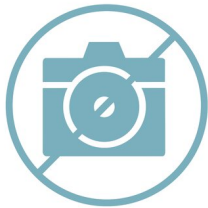

PCB headers, nominal cross section: 1.5 mm², color: black, nominal current: 8 A, rated voltage (III/2): 160 V, contact surface: Tin, type of contact: Male connector, number of potentials: 6, number of rows: 1, number of positions: 6, number of connections: 6, product range: MCV 1,5/..-GF-THR, pitch: 3.81 mm, mounting: THR soldering, pin layout: Linear pinning, solder pin [P]: 1.4 mm, number of solder pins per potential: 1, plug-in system: COMBICON MC 1,5, Pin connector pattern alignment: Standard, locking: Screw locking, mounting: Threaded flange, type of packaging: packed in cardboard, For user information and design recommendations for through-hole reflow technology, go to: Downloads

PCB header

PCB header - MCV 1,5/ 6-GF-3,81 P26 THR - 1707670

<https://www.phoenixcontact.com/us/products/1707670>

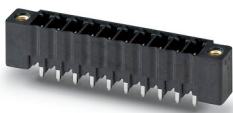

PCB headers, nominal cross section: 1.5 mm², color: black, nominal current: 8 A, rated voltage (III/2): 160 V, contact surface: Tin, type of contact: Male connector, number of potentials: 6, number of rows: 1, number of positions: 6, number of connections: 6, product range: MCV 1,5/..-GF-THR, pitch: 3.81 mm, mounting: THR soldering, pin layout: Linear pinning, solder pin [P]: 2.6 mm, number of solder pins per potential: 1, plug-in system: COMBICON MC 1,5, Pin connector pattern alignment: Standard, locking: Screw locking, mounting: Threaded flange, type of packaging: packed in cardboard, For user information and design recommendations for through-hole reflow technology, go to: Downloads

PCB connector - MC 1,5/ 6-STF-3,81



1827745

<https://www.phoenixcontact.com/us/products/1827745>

PCB header

PCB header - MCD 1,5/ 6-G1F-3,81 - 1842953

<https://www.phoenixcontact.com/us/products/1842953>



PCB headers, nominal cross section: 1.5 mm², color: green, nominal current: 8 A, rated voltage (III/2): 160 V, contact surface: Tin, type of contact: Male connector, number of potentials: 12, number of rows: 2, number of positions: 6, number of connections: 12, product range: MCD 1,5/..-G1F, pitch: 3.81 mm, mounting: Wave soldering, pin layout: Linear pinning, solder pin [P]: 3.5 mm, number of solder pins per potential: 1, plug-in system: COMBICON MC 1,5, Pin connector pattern alignment: Standard, locking: Screw locking, mounting: Threaded flange, type of packaging: packed in cardboard, In combination with MCV plug components, both an MCVW and an MCVR plug must be used.

Phoenix Contact 2022 © - all rights reserved

<https://www.phoenixcontact.com>

Phoenix Contact USA
586 Fulling Mill Road
Middletown, PA 17057, United States
(+717) 944-1300
info@phoenixcon.com